

P-Channel 20V(D-S) MOSFET

Product summary		
V_{DS}	-20	V
$R_{DS(ON)}$ (at $V_{GS}=-4.5V$) Typ.	30	m Ω
$R_{DS(ON)}$ (at $V_{GS}=-2.5V$) Typ.	36	m Ω
I_D ($T_A=25^\circ C$)	-5	A

Features

- Trench Power LV MOSFET technology
- Low Gate Charge
- Low $R_{DS(ON)}$

Applications

- Power management
- Video monitor

Pin Configuration

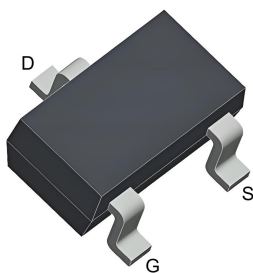

SOT-23

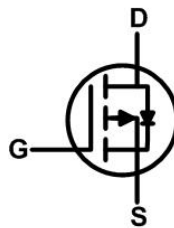

Packing Information

Device	Package	Marking	Reel Size	Quantity(Min. Package)
ECDA3415	SOT-23	3415XX	7"	3000pcs

XX:Factory code

Absolute Maximum Ratings (at $T_A=25^\circ C$ Unless Otherwise Noted)

Symbol	Parameter	Rating	Units
V_{DS}	Drain-Source Voltage	-20	V
V_{GS}	Gate-Source Voltage	± 12	V
I_D	Continuous Drain Current at $V_{GS}=-10V$	$T_A=25^\circ C$	-5
		$T_A=70^\circ C$	-4
I_{DM}	Pulse Drain Current Tested ^A	-22	A
P_D	Power Dissipation	$T_A=25^\circ C$	1.2
T_J, T_{STG}	Junction and Storage Temperature Range	-55 to +150	$^\circ C$

Thermal Characteristics

Symbol	Parameter	Typical	Units
$R_{\theta JA}$	Thermal Resistance-Junction to ambient ^B	104	$^\circ C/W$

Electrical Characteristics (at $T_J = 25^\circ\text{C}$ Unless Otherwise Noted)

Symbol	Parameter	Condition	Min.	Typ.	Max.	Units
Static Parameters						
BV_{DSS}	Drain-Source Breakdown Voltage	$V_{GS}=0V, I_D=-250\mu A$	-20	--	--	V
I_{DSS}	Zero Gate Voltage Drain Current	$V_{DS}=-20V, V_{GS}=0V$	--	--	-1	μA
I_{GSS}	Gate-Body Leakage Current	$V_{DS}=0V, V_{GS}=\pm 8V$	--	--	± 2	μA
$V_{GS(th)}$	Gate Threshold Voltage	$V_{DS}=V_{GS}, I_D=-250\mu A$	-0.4	--	-1.0	V
$R_{DS(on)}$	Drain-Source On-State Resistance ^C	$V_{GS}=-4.5V, I_D=-5A$	--	30	41	m Ω
		$V_{GS}=-2.5V, I_D=-4A$	--	36	55	m Ω
		$V_{GS}=-1.8V, I_D=-2A$	--	55	95	m Ω
V_{SD}	Forward Voltage	$I_{SD}=-5A, V_{GS}=0V$	--	--	-1.2	V
Dynamic Parameters ^D						
C_{iss}	Input Capacitance	$V_{GS}=0V, V_{DS}=-10V$ $f=1\text{MHz}$	--	935	--	pF
C_{oss}	Output Capacitance		--	210	--	pF
C_{rss}	Reverse Transfer Capacitance		--	112	--	pF
Q_g	Total Gate Charge	$V_{DS}=-10V, I_D=-4A$ $V_{GS}=-4.5V$	--	7.5	--	nC
Q_{gs}	Gate-Source Charge		--	1.3	--	nC
Q_{gd}	Gate-Drain Charge		--	1.5	--	nC
$t_{D(on)}$	Turn-on Delay Time	$V_{DD}=-10V$ $R_L=2.5\Omega, V_{GS}=-4.5V, R_{GEN}=3\Omega$	--	15	--	nS
t_r	Turn-on Rise Time		--	65	--	nS
$t_{D(off)}$	Turn-off Delay Time		--	23	--	nS
t_f	Turn-off Fall Time		--	14	--	nS

A. Repetitive Rating: Pulse Width Limited by Maximum Junction Temperature.

B. Device mounted on FR-4 PCB, 1 inch x 1 inch x 0.062 inch.

C. Pulse Test: Pulse Width $\leq 300\mu s$, Duty cycle $\leq 0.5\%$.

D. Guaranteed by design, not subject to production testing.

Typical Characteristics

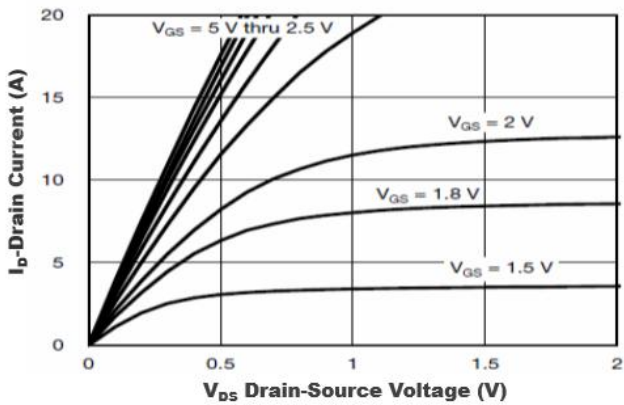

Figure1. Output Characteristics

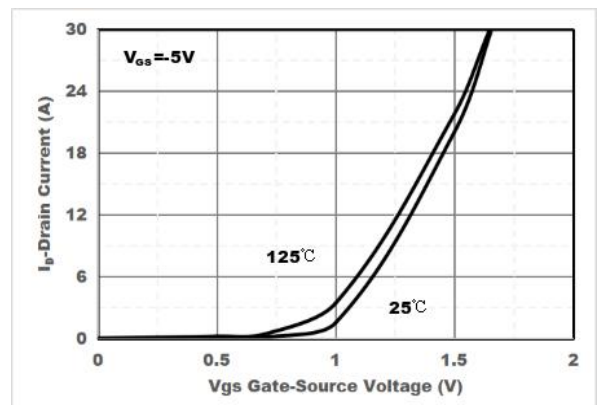

Figure2. Transfer Characteristics

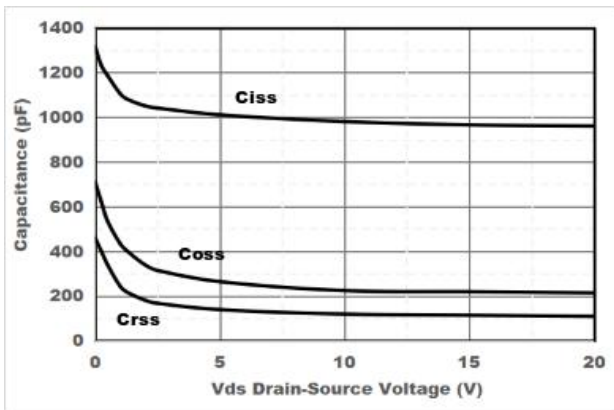

Figure3. Capacitance Characteristics

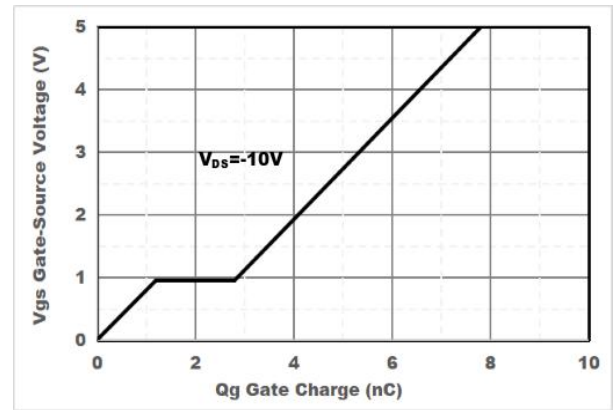

Figure4. Gate Charge

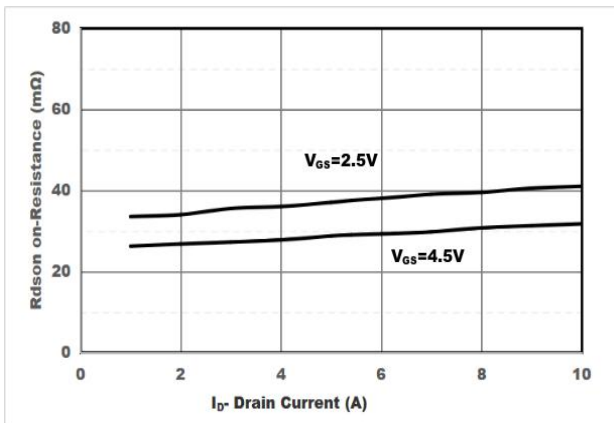

Figure5. Drain-Source on Resistance

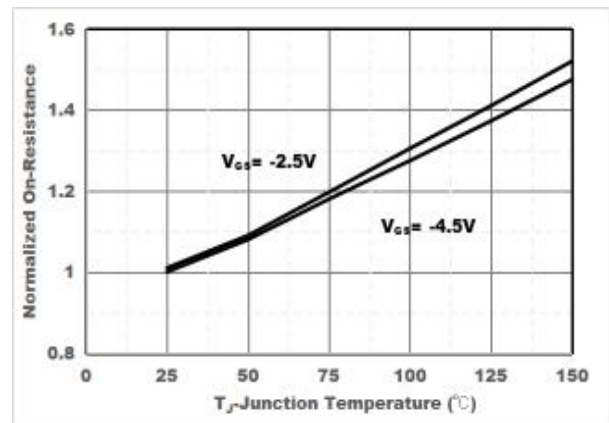

Figure6. Drain-Source on Resistance

Typical Characteristics

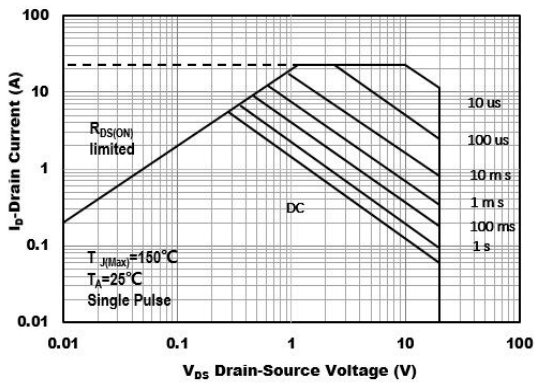

Figure7. Safe Operation Area

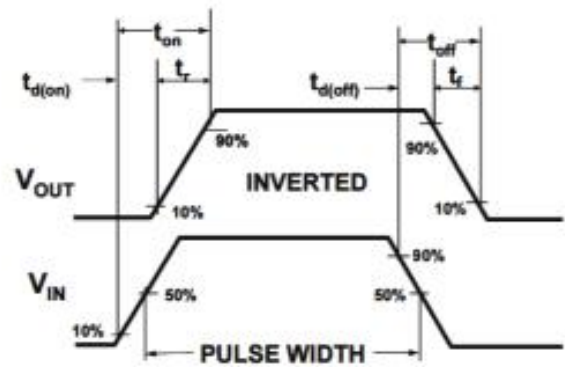
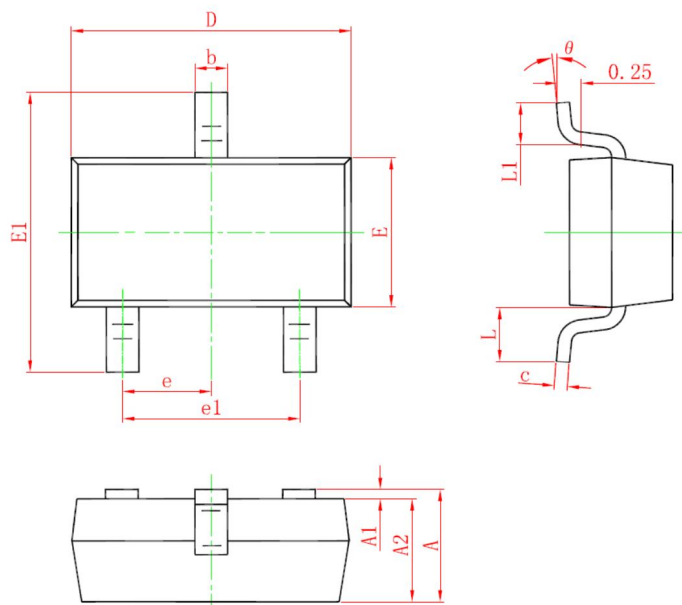

Figure8. Switching wave

SOT-23 Package Information



Symbol	Dimensions In Millimeters		Dimensions In Inches	
	Min.	Max.	Min.	Max.
A	0.900	1.150	0.035	0.045
A1	0.000	0.100	0.000	0.004
A2	0.900	1.050	0.035	0.041
b	0.300	0.500	0.012	0.020
c	0.080	0.150	0.003	0.006
D	2.800	3.000	0.110	0.118
E	1.200	1.400	0.047	0.055
E1	2.250	2.550	0.089	0.100
e	0.950 TYP.		0.037 TYP.	
e1	1.800	2.000	0.071	0.079
L	0.550 REF.		0.022 REF.	
L1	0.300	0.500	0.012	0.020
θ	0°	8°	0°	8°