

N-Channel 650V(D-S) MOSFET

Product summary		
V_{DS}	650	V
$R_{DS(ON)}$ (at $V_{GS}=10V$) Typ.	1.1	Ω
I_D ($T_C=25^\circ C$)	7	A

Features
<ul style="list-style-type: none"> ● Fast switching ● Improved dv/dt capability
Applications
<ul style="list-style-type: none"> ● Switch Mode Power Supply (SMPS)

Pin Configuration



TO-252

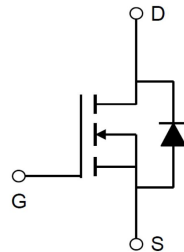

Packing Information

Device	Package	Reel Size	Quantity(Min. Package)
ECS7N65FD	TO-252	13"	2500pcs

Absolute Maximum Ratings (at $T_A=25^\circ C$ Unless Otherwise Noted)

Symbol	Parameter	Rating	Units
V_{DS}	Drain-Source Voltage	650	V
V_{GS}	Gate-Source Voltage	± 30	V
I_D	Continuous Drain Current	$T_C=25^\circ C$	7
I_{DM}	Pulse Drain Current Tested ^A		28
E_{AS}	Single Pulse Avalanche Energy ^B		180
I_{AS}	Avalanche Current ^A		6
E_{AR}	Repetitive Avalanche Energy ^A		0.72
P_D	Power Dissipation	$T_C=25^\circ C$	97
T_J, T_{STG}	Junction and Storage Temperature Range		-55 to +150

Thermal Characteristics

Symbol	Parameter	Typical	Units
$R_{\theta JC}$	Thermal Resistance-Junction to Case ^C	1.29	$^\circ C/W$
$R_{\theta JA}$	Thermal Resistance-Junction to Ambient ^C	60	$^\circ C/W$

Electrical Characteristics (at $T_J = 25^\circ\text{C}$ Unless Otherwise Noted)

Symbol	Parameter	Condition	Min.	Typ.	Max.	Units
Static Parameters						
BV_{DSS}	Drain-Source Breakdown Voltage	$V_{GS}=0V, I_D=250\mu A$	650	--	--	V
I_{DSS}	Zero Gate Voltage Drain Current	$V_{DS}=650V, V_{GS}=0V$	--	--	1	μA
I_{GSS}	Gate-Body Leakage Current	$V_{DS}=0V, V_{GS}=\pm 30V$	--	--	± 100	nA
$V_{GS(th)}$	Gate Threshold Voltage	$V_{DS}=V_{GS}, I_D=250\mu A$	3.0	--	4.0	V
$R_{DS(ON)}$	Drain-Source On-State Resistance ^D	$V_{GS}=10V, I_D=3.5A$	--	1.1	1.35	Ω
Dynamic Parameters ^E						
C_{iss}	Input Capacitance	$V_{GS}=0V, V_{DS}=25V$ $f=1\text{MHz}$	--	956	--	pF
C_{oss}	Output Capacitance		--	89.3	--	pF
C_{rss}	Reverse Transfer Capacitance		--	1.5	--	pF
R_g	Gate Resistance		--	2.3	--	Ω
Q_g	Total Gate Charge	$V_{DD}=520V, I_D=7A$ $V_{GS}=10V$	--	18	--	nC
Q_{gs}	Gate-Source Charge		--	4.8	--	nC
Q_{gd}	Gate-Drain Charge		--	7.8	--	nC
$t_{D(on)}$	Turn-on Delay Time	$V_{DD}=325V, I_D=7A,$ $R_G=25\Omega$	--	40	--	ns
t_r	Turn-on Rise Time		--	16.3	--	ns
$t_{D(off)}$	Turn-off Delay Time		--	93.6	--	ns
t_f	Turn-off Fall Time		--	32	--	ns
Drain-Source Body Diode Characteristics						
I_S	Continuous Body Diode Current	$T_C=25^\circ\text{C}$	--	--	7	A
I_{SM}	Pulsed Diode Forward Current		--	--	28	A
V_{SD}	Body Diode Voltage	$I_S=3.5A, V_{GS}=0V$	--	--	1.2	V
t_{rr}	Reverse Recovery Time	$V_R=325V, I_S=7A$ $di/dt=100A/\mu s$	--	281	--	ns
Q_{rr}	Reverse Recovery Charge		--	2.5	--	μC

A. Repetitive Rating: Pulse width limited by maximum junction temperature.

B. $T_J=25^\circ\text{C}$, $V_{DD}=50V$, $L=10\text{mH}$, $R_G=25\Omega$.

C. The data tested by surface mounted on a 1 inch x 1 inch FR-4 board with 20Z copper.

D. Pulse Test: Pulse Width $\leq 300\mu s$, Duty cycle $\leq 2\%$.

E. Guaranteed by design, not subject to production testing.

Typical Characteristics

Figure 1. Output Characteristics ($T_J = 25^\circ\text{C}$)

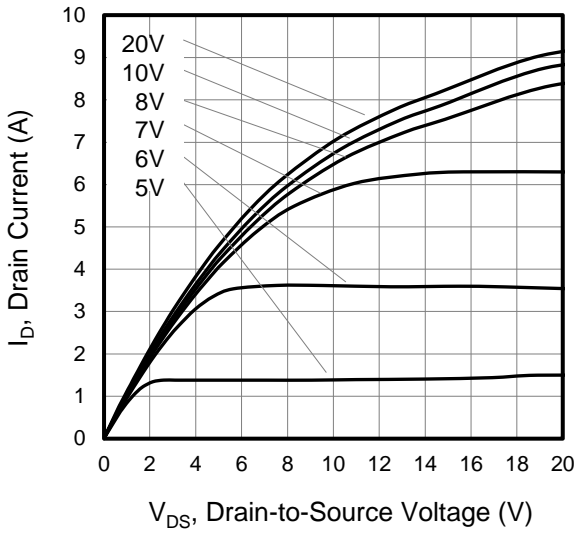

Figure 2. Body Diode Forward Voltage

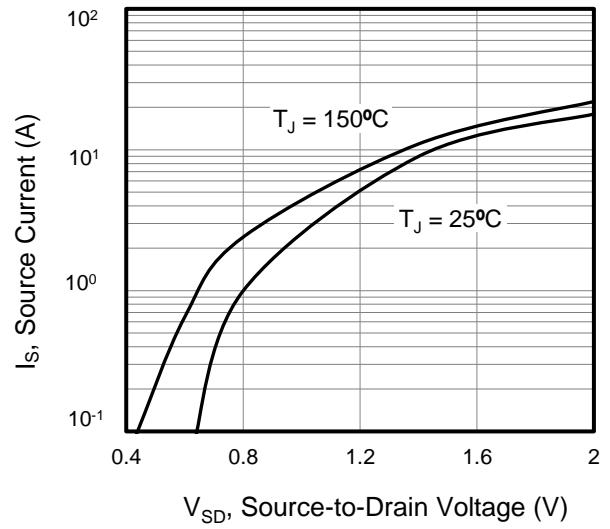

Figure 3. Drain Current vs. Temperature

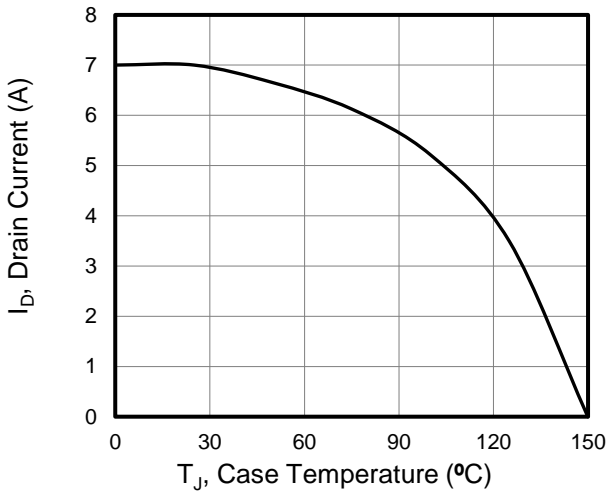

Figure 4. BV_{DSS} Variation vs. Temperature

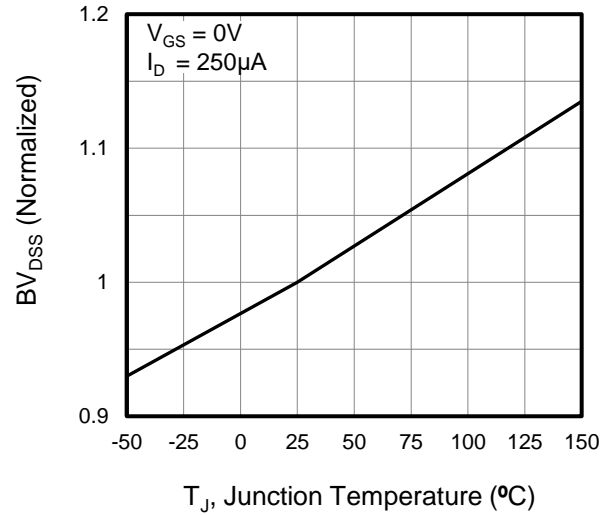

Figure 5. Transfer Characteristics

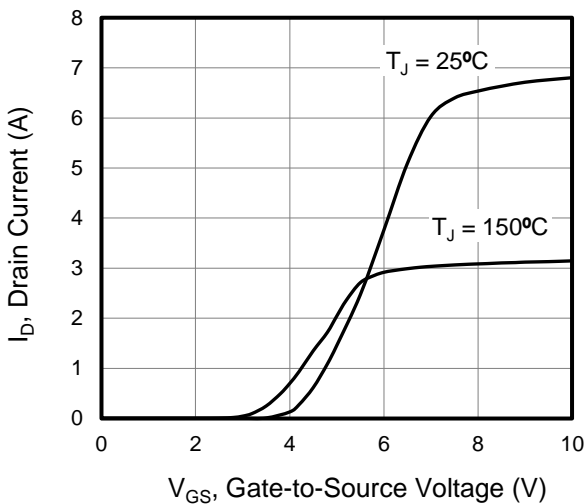
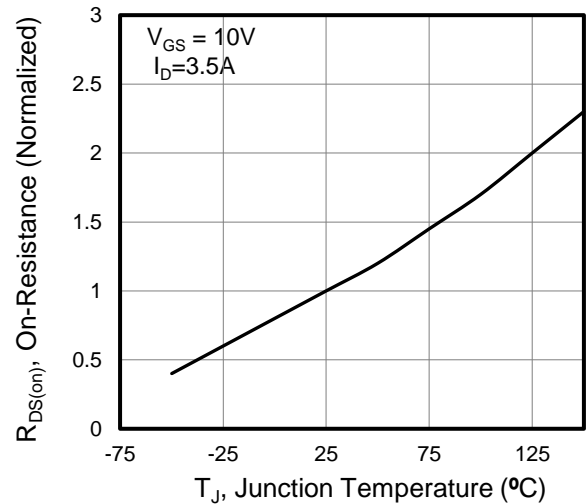

Figure 6. On-Resistance vs. Temperature



Typical Characteristics

Figure 7. Capacitance

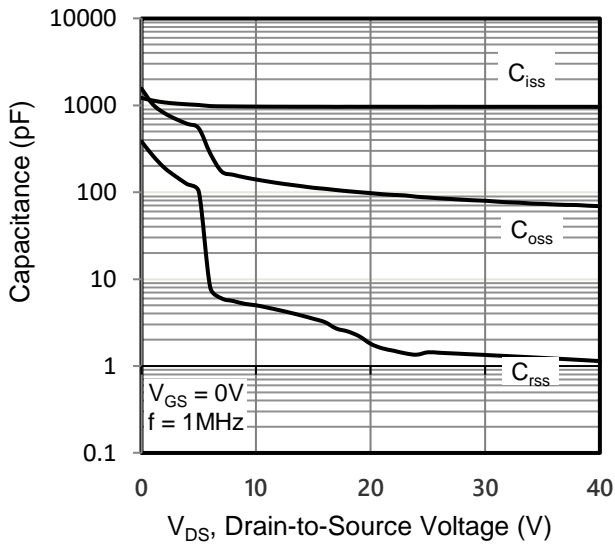

Figure 8. Gate Charge

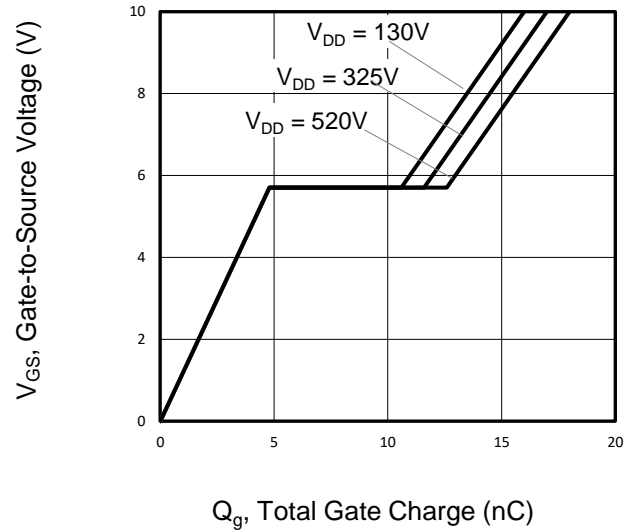
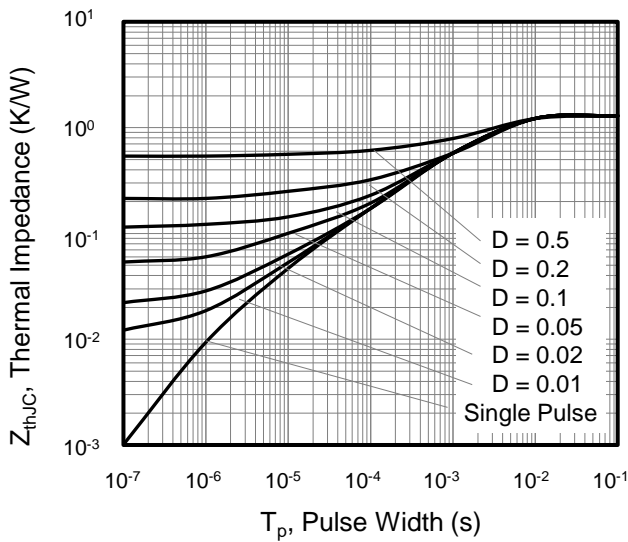

Figure 9. Transient Thermal Impedance



Typical Characteristics

Figure A: Gate Charge Test Circuit and Waveform

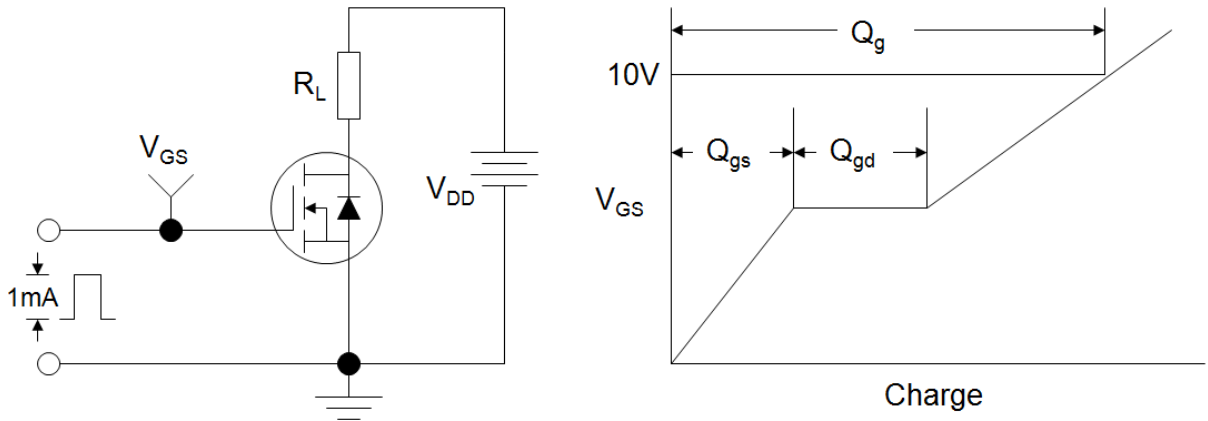

Figure B: Resistive Switching Test Circuit and Waveform

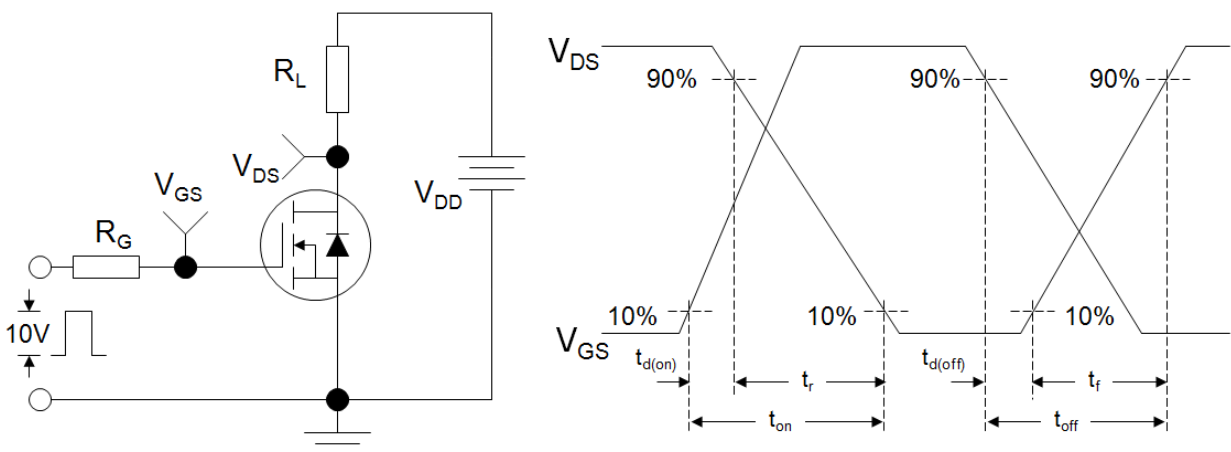
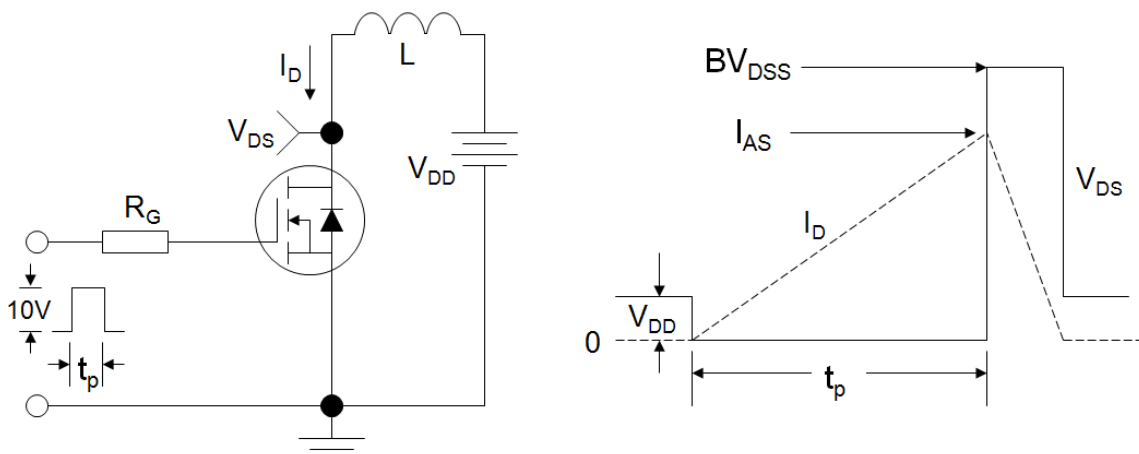
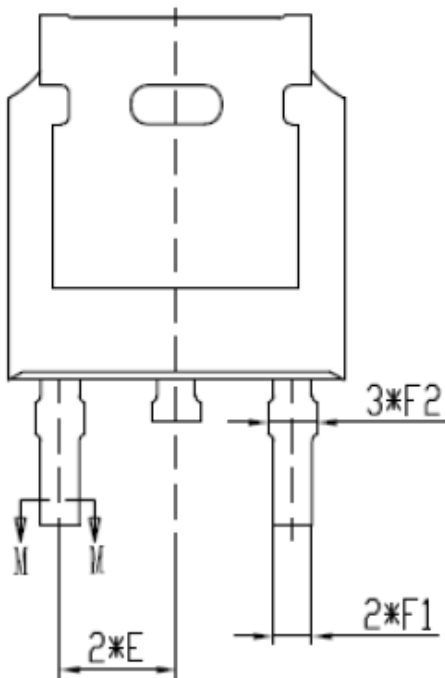
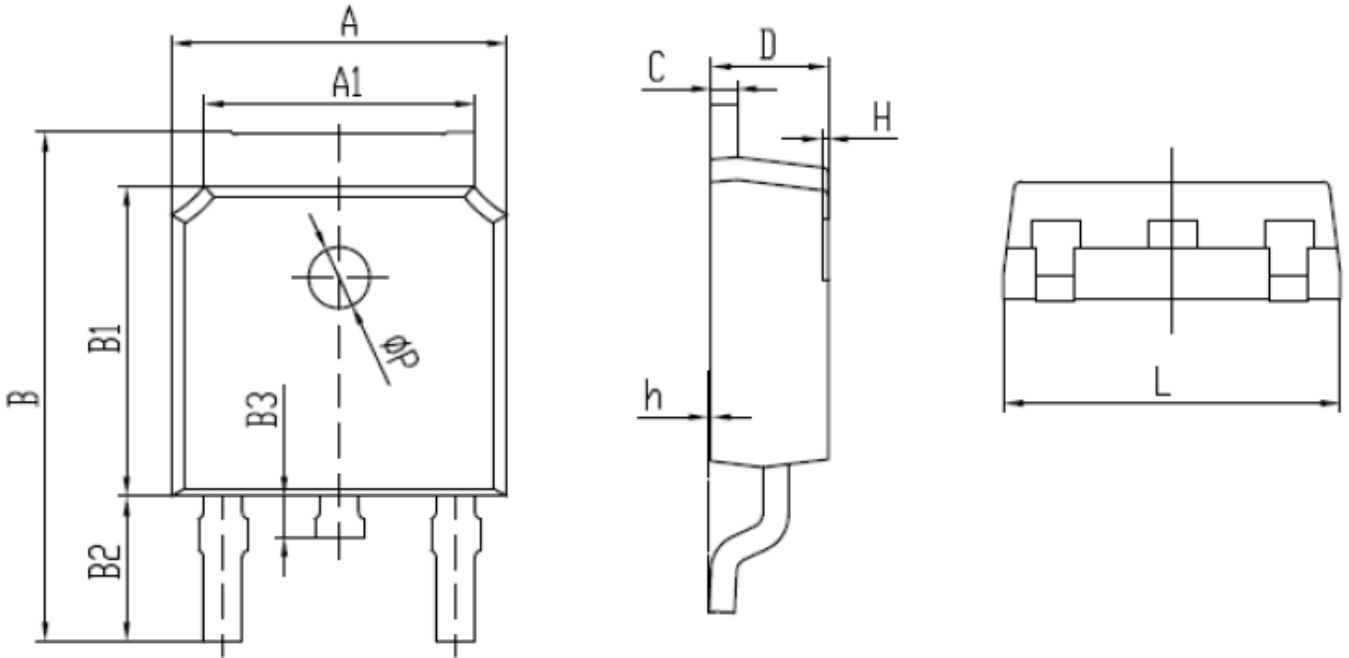

Figure C: Unclamped Inductive Switching Test Circuit and Waveform



TO-252 Package Information(unit:mm)



SYMBOLS	MILLIMETERS	
	MIN	MAX
A	6.50	6.70
A1	5.16	5.46
B	9.77	10.17
B1	6.00	6.20
B2	2.60	3.00
B3	0.70	0.90
C	0.45	0.61
D	2.20	2.40
E	2.19	2.39
F1	0.67	0.87
F2	0.76	0.96
H	0.00	0.30
h	0.00	0.13
L	6.50	6.70
ΦP	1.10	1.30