

N-Channel 40V(D-S) MOSFET

Product summary		
V_{DS}	40	V
$R_{DS(ON)}$ (at $V_{GS}=10V$) Typ.	7.6	m Ω
$R_{DS(ON)}$ (at $V_{GS}=4.5V$) Typ.	9.9	m Ω
I_D ($T_C=25^\circ C$)	30	A

Features

- Advanced Trench Technology
- Low $R_{DS(ON)}$

Applications

- Load switching
- PWM Applications
- Power Management

Pin Configuration

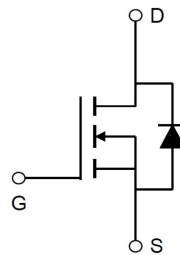
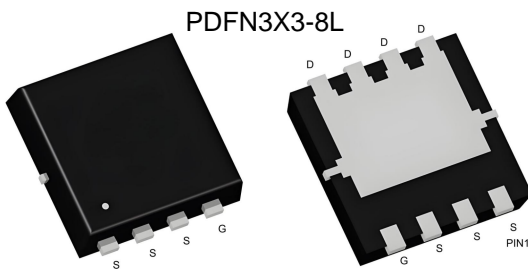

Packing Information

Device	Package	Reel Size	Quantity(Min. Package)
ECAL30N04A	PDFN3X3-8L	13"	5000pcs

Absolute Maximum Ratings (at $T_A=25^\circ C$ Unless Otherwise Noted)

Symbol	Parameter	Rating	Units
V_{DS}	Drain-Source Voltage	40	V
V_{GS}	Gate-Source Voltage	± 20	V
I_D	Continuous Drain Current	$T_C=25^\circ C$	30
		$T_C=70^\circ C$	24
I_{DM}	Pulse Drain Current Tested ^A	115	A
E_{AS}	Single Pulse Avalanche Energy ^B	36	mJ
P_D	Power Dissipation @ $T_C=25^\circ C$	15	W
T_J, T_{STG}	Junction and Storage Temperature Range	-55 to +150	$^\circ C$

Thermal Characteristics

Symbol	Parameter	Typical	Units
$R_{\theta JC}$	Thermal Resistance-Junction to case max	8.3	$^\circ C/W$

Electrical Characteristics (at $T_J = 25^\circ\text{C}$ Unless Otherwise Noted)

Symbol	Parameter	Condition	Min.	Typ.	Max.	Units
Static Parameters						
BV_{DSS}	Drain-Source Breakdown Voltage	$V_{GS}=0V, I_D=250\mu A$	40	--	--	V
I_{DSS}	Zero Gate Voltage Drain Current	$V_{DS}=40V, V_{GS}=0V$	--	--	1.0	μA
I_{GSS}	Gate-Body Leakage Current	$V_{DS}=0V, V_{GS}=\pm 20V$	--	--	± 100	nA
$V_{GS(th)}$	Gate Threshold Voltage	$V_{DS}=V_{GS}, I_D=250\mu A$	1.0	1.5	2.5	V
$R_{DS(on)}$	Drain-Source On-State Resistance ^C	$V_{GS}=10V, I_D=30A$	--	7.6	10	m Ω
		$V_{GS}=4.5V, I_D=20A$	--	9.9	13.5	m Ω
V_{SD}	Diode Forward Voltage	$I_S=30A, V_{GS}=0V$	--	--	1.2	V
Dynamic Parameters ^D						
C_{iss}	Input Capacitance	$V_{GS}=0V, V_{DS}=20V$ $f=1\text{MHz}$	--	1620	--	pF
C_{oss}	Output Capacitance		--	140	--	pF
C_{rss}	Reverse Transfer Capacitance		--	121	--	pF
Q_g	Total Gate Charge	$V_{DS}=20V, I_D=15A$ $V_{GS}=10V$	--	5.2	--	nC
Q_{gs}	Gate-Source Charge		--	2.9	--	nC
Q_{gd}	Gate-Drain Charge		--	1.2	--	nC
$t_{D(on)}$	Turn-on Delay Time	$V_{DS}=20V$ $, R_G=6\Omega, R_L=20\Omega,$ $I_D=1A,$ $V_{GS}=10V$	--	10	--	ns
t_r	Turn-on Rise Time		--	6.7	--	ns
$t_{D(off)}$	Turn-off Delay Time		--	19	--	ns
t_f	Turn-off Fall Time		--	12	--	ns
t_{rr}	Reverse recovery time		--	18.7	--	ns
Q_{rr}	Reverse recovery charge	$I_F=5A,$ $di/dt=100\text{ A}/\mu\text{S}$	--	4.5	--	nC

A. Repetitive Rating: Pulse Width Limited by Maximum Junction Temperature.

B. EAS condition: $T_J=25^\circ\text{C}, R_G=25\Omega, V_{GS}=10V, L=0.5\text{mH}, I_{AS}=12A$.

C. Pulse Test: Pulse Width $\leq 300\mu\text{s}$, Duty Cycle $\leq 0.5\%$.

D. Guaranteed by design, not subject to production testing.

Typical Characteristics

Figure 1: Output Characteristics

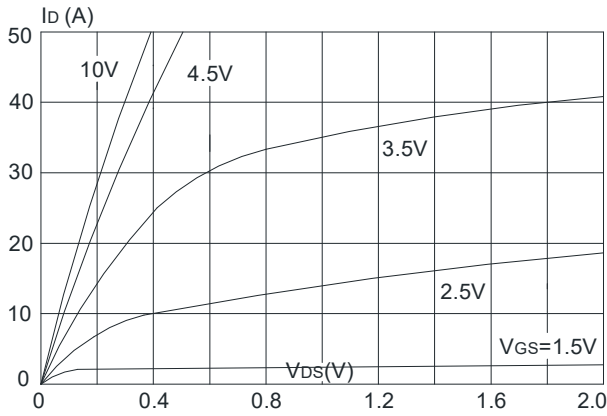

Figure 2: Typical Transfer Characteristics

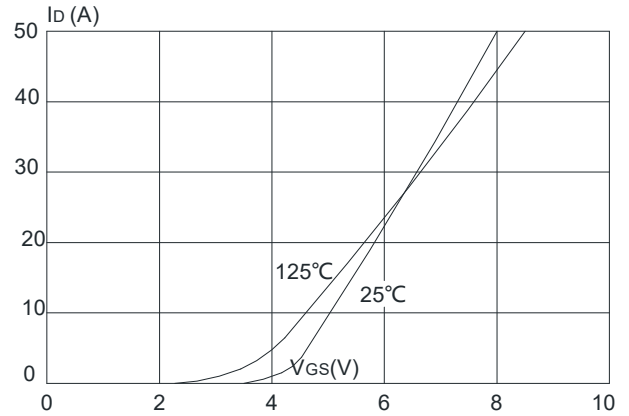

Figure 3: On-resistance vs. Drain Current

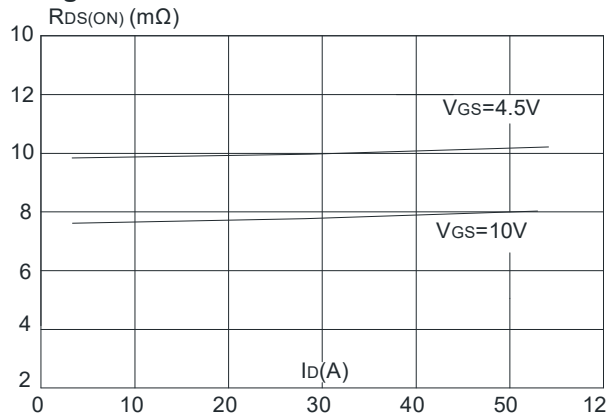

Figure 4: Body Diode Characteristics

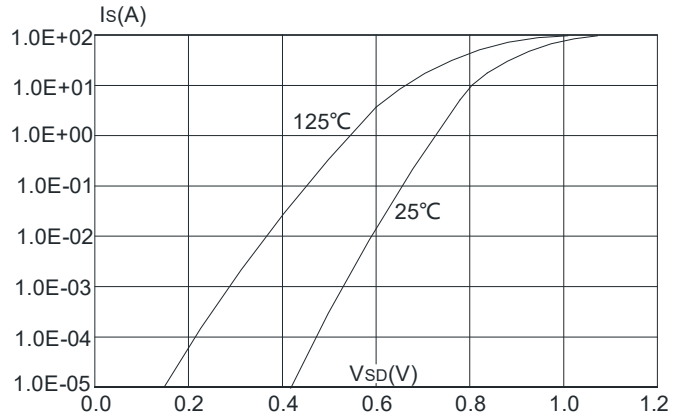

Figure 5: Gate Charge Characteristics

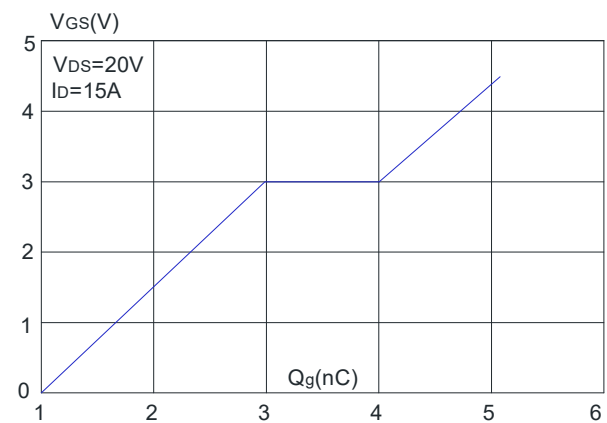
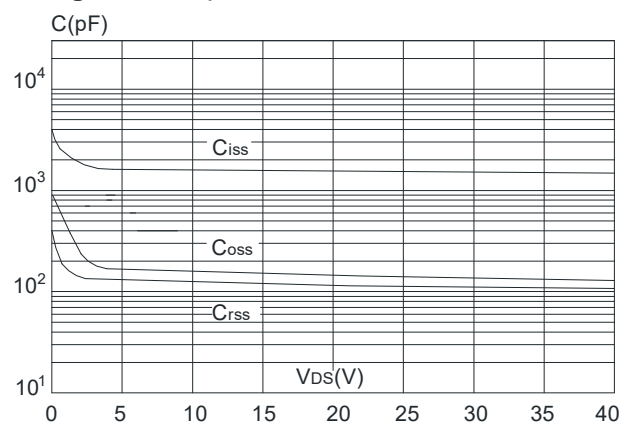

Figure 6: Capacitance Characteristics



Typical Characteristics

Figure 7: Normalized Breakdown Voltage vs. Junction Temperature

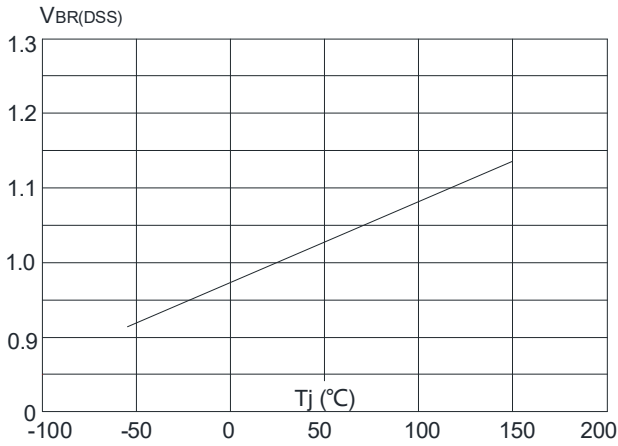

Figure 8: Normalized on Resistance vs. Junction Temperature

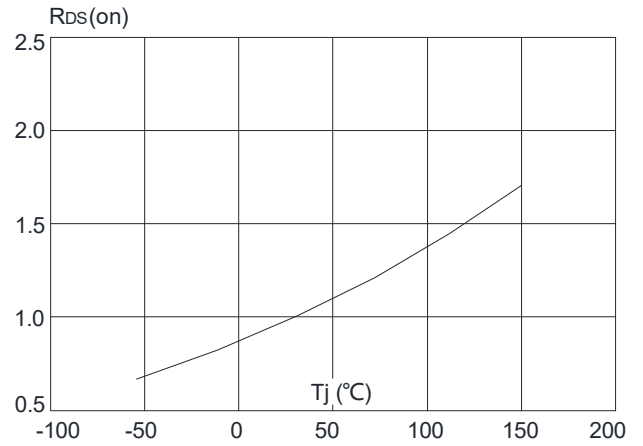

Figure 9: Maximum Safe Operating Area

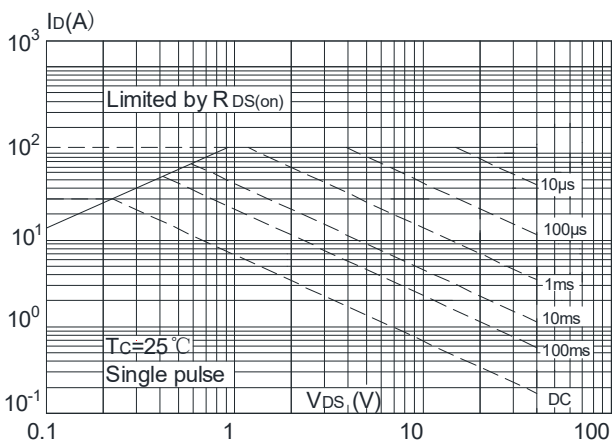

Figure 10: Maximum Continuous Drain Current vs. Case Temperature

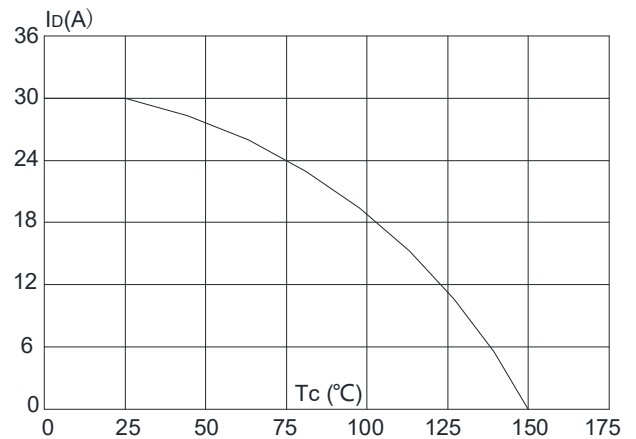
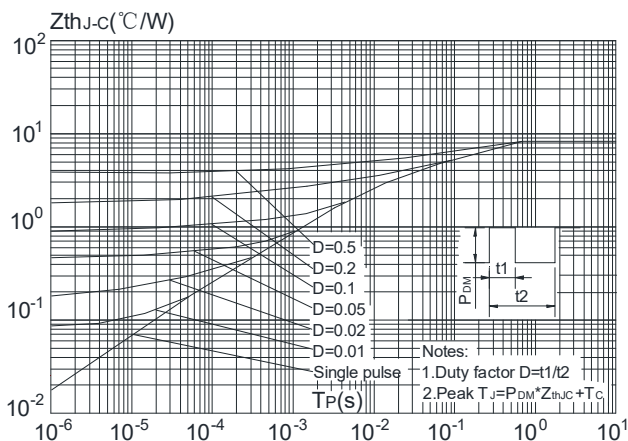

Figure 11: Maximum Effective Transient Thermal Impedance, Junction-to-Case



Test Circuit

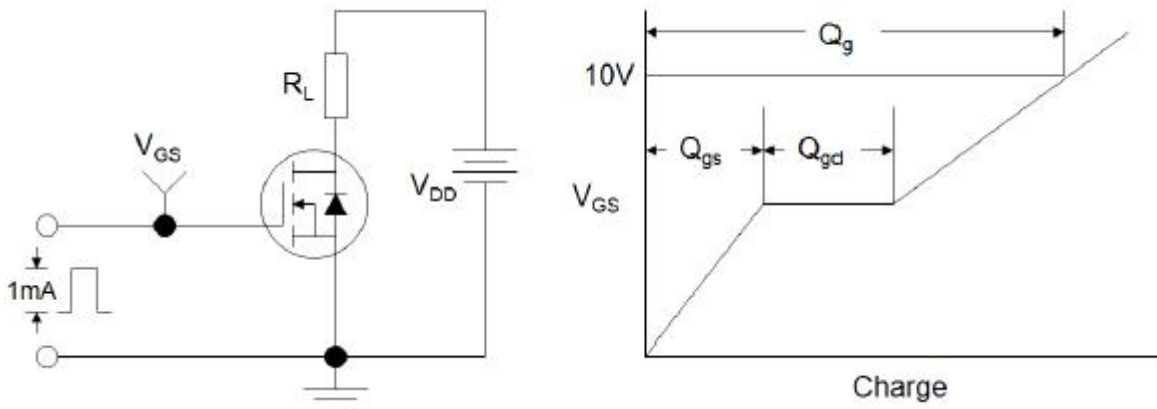

Figure1:Gate Charge Test Circuit & Waveform

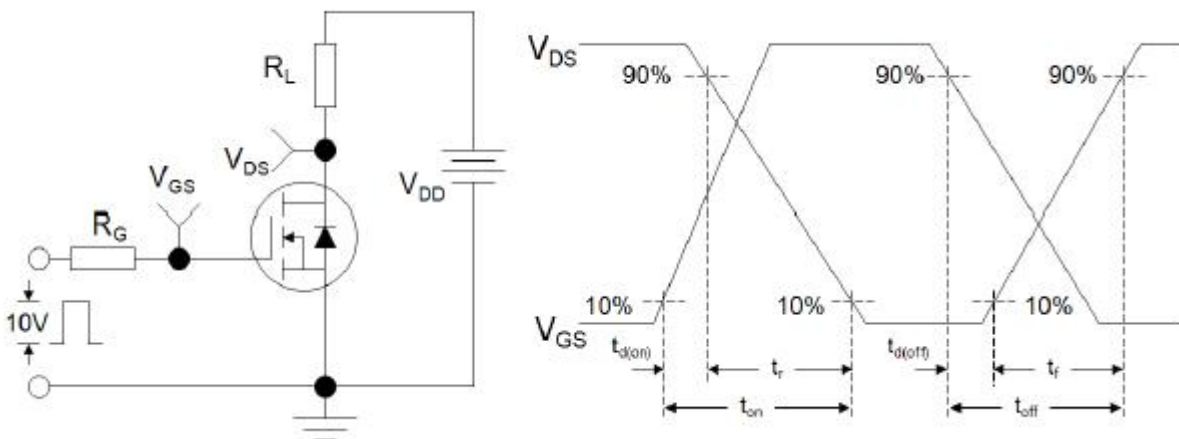

Figure 2: Resistive Switching Test Circuit & Waveforms

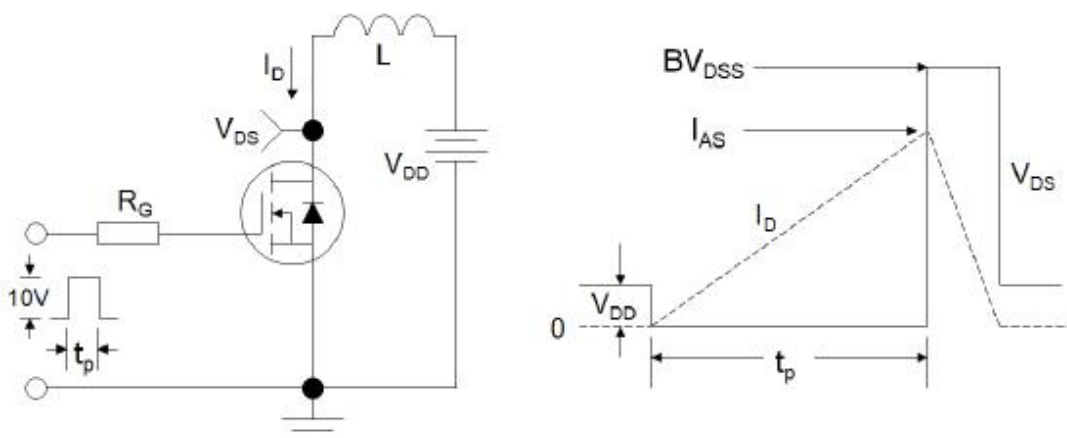
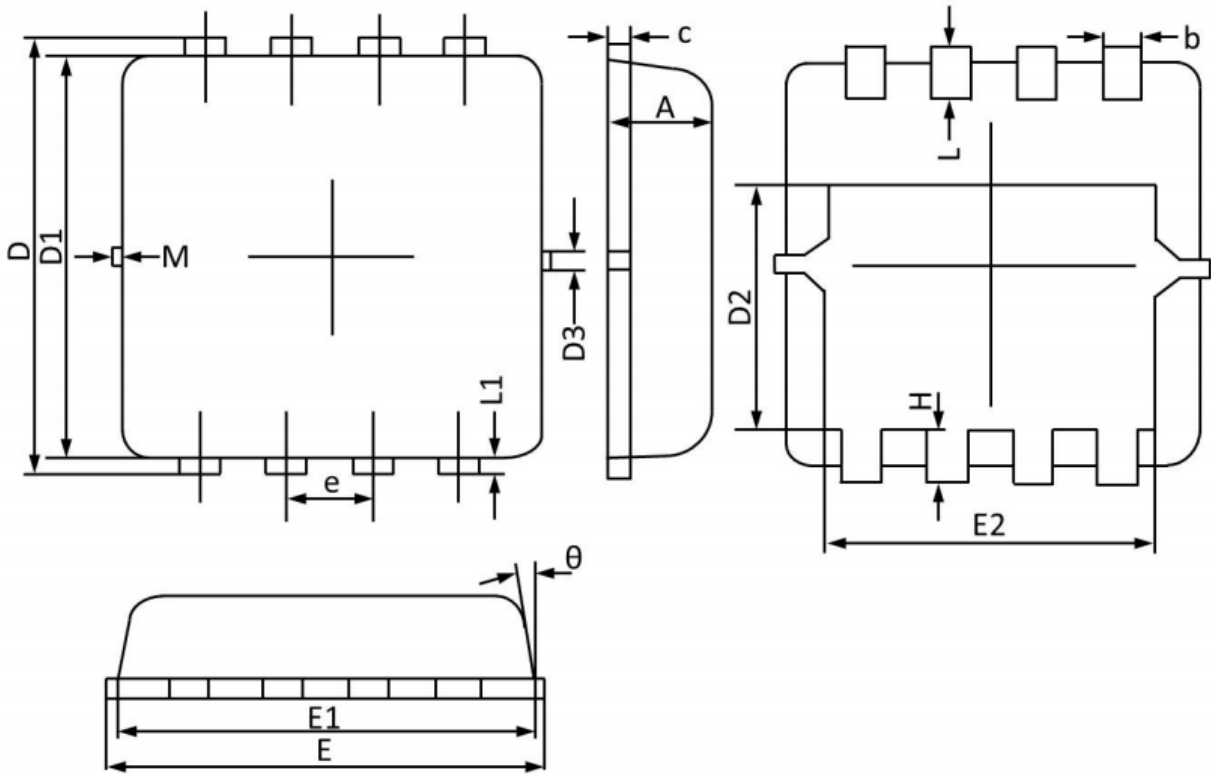

Figure 3:Unclamped Inductive Switching Test Circuit & Waveforms

PDFN3X3-8L Package Information (unit:mm)



DIMENSIONS

Symbol	Min	Typ	Max	Symbol	Min	Typ	Max
A	0.70	0.75	0.80	b	0.25	0.30	0.35
C	0.10	0.15	0.25	D	3.25	3.35	3.45
D1	3.00	3.10	3.20	D2	1.78	1.88	1.98
D3	--	0.13	--	E	3.20	3.30	3.40
E1	3.00	3.15	3.20	E2	2.39	2.49	2.59
e	0.65BSC			H	0.30	0.39	0.50
L	0.30	0.40	0.50	L1	--	0.13	--
theta	--	10°	12°	M	*	*	0.15