

N-Channel 20V (D-S) MOSFET with PNP Transistor

$V_{(BR)DSS}/V_{CEO}$	$R_{DS(on)MAX}$	I_D/I_C
20V	0.3Ω@-4.5V	0.5A
	0.6Ω@-2.5V	
-25V	/	-2.5A

Features

- Small package DFN3x2-8L
- Low collector-emitter saturation voltage V_{CEsat}
- High DC current gain
- RoHS and Halogen-Free Compliant

Applications

- Charging Switch for Portable Devices
- Power management

Pin Configuration

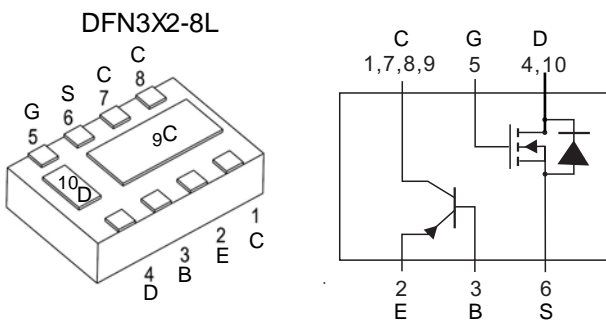

Packing Information

Device	Marking	Reel Size	Tape Width	Quantity
EC5314	32M .XXX	7"	8mm	3000pcs

Absolute Maximum Ratings ($T_J=25^\circ\text{C}$ Unless Otherwise Noted)

Symbol	Parameter	Value	Unit
PNP Transistor			
V_{CBO}	Collector-Base Voltage	-25	V
V_{CEO}	Collector-Emitter Voltage	-25	V
V_{EBO}	Emitter-Base Voltage	-6.5	V
I_C	Collector Current	-2.5	A
N-MOSFET			
V_{DS}	Drain-Source Voltage	20	V
V_{GS}	Gate-Source Voltage	±12	V
I_D	Drain Current -Continuous	0.5	A
I_{DM}	Drain Current - Pulse	2.0	A
Power Dissipation, Temperature and Thermal Resistance			
P_D	Power Dissipation	2.0	W
$R_{\theta JA}$	Thermal Resistance from Junction to Ambient (note1)	175	$^\circ\text{C}/\text{W}$
	Thermal Resistance from Junction to Ambient (note2)	110	$^\circ\text{C}/\text{W}$
T_J	Junction Temperature	150	$^\circ\text{C}$
T_{stg}	Storage Temperature	-55~+150	$^\circ\text{C}$
T_L	Lead Temperature	260	$^\circ\text{C}$

PNP TRANSISTOR ELECTRICAL CHARACTERISTICS (T_J=25°C unless otherwise specified)

Parameter	Symbol	Test conditions	Min	Typ	Max	Unit
Collector-base breakdown voltage	V _{(BR)CBO}	I _C =-0.1mA, I _E =0	-25			V
Collector-emitter breakdown voltage	V _{(BR)CEO} *	I _C =-10mA, I _B =0	-25			V
Emitter-base breakdown voltage	V _{(BR)EBO}	I _E =-0.1mA, I _C =0	-6.5			V
Collector cut-off current	I _{CBO}	V _{CB} =-20V, I _E =0			-0.1	µA
Emitter cut-off current	I _{EBO}	V _{EB} =-6V, I _C =0			-0.1	µA
DC current gain	h _{FE} *	V _{CE} =-2V, I _C =-0.01A	300			
		V _{CE} =-2V, I _C =-0.1A	300			
		V _{CE} =-2V, I _C =-2A	150			
		V _{CE} =-2V, I _C =-6A	15			
Collector-emitter saturation voltage	V _{CE(sat)} *	I _C =-1A, I _B =-100mA		-160	-200	mV
		I _C =-1.5A, I _B =-150mA		-180	-250	mV
		I _C =-2A, I _B =-200mA		-200	-300	mV
Base-emitter saturation voltage	V _{BE(sat)} *	I _C =-3.5A, I _B =-350mA			-1.075	V
Base-emitter voltage	V _{BE(on)} *	V _{CE} =-2V, I _C =-3.5A			-0.95	V
Transition frequency	f _T	V _{CE} =-10V, I _C =-50mA, f=100MHz	150			MHz

N-ch MOSFET ELECTRICAL CHARACTERISTICS (T_J=25°C unless otherwise specified)

Parameter	Symbol	Test conditions	Min	Typ	Max	Unit
STATIC PARAMETERS						
Drain-source breakdown voltage	V _{(BR)DSS}	V _{GS} = 0V, I _D =250µA	20			V
Zero gate voltage drain current	I _{DSS}	V _{DS} = 16V, V _{GS} = 0V			0.1	µA
Gate-body leakage current	I _{GSS}	V _{GS} = ±4.5V, V _{DS} = 0V			±1	µA
Gate threshold voltage	V _{GS(th)}	V _{DS} = V _{GS} , I _D = 250µA	0.45	0.75	1.2	V
Drain-source on-resistance	R _{DS(on)}	V _{GS} = 4.5V, I _D = 0.6A			0.3	Ω
		V _{GS} = 2.5V, I _D = 0.5A			0.6	Ω
Forward transconductance	g _{fs}	V _{DS} = 10V, I _D = 0.4A	0.5			S
Diode forward voltage	V _{SD} *	I _S =0.15A, V _{GS} = 0V		0.7	1.3	V

PNP TRANSISTOR TYPICAL CHARACTERISTICS

Static Characteristic

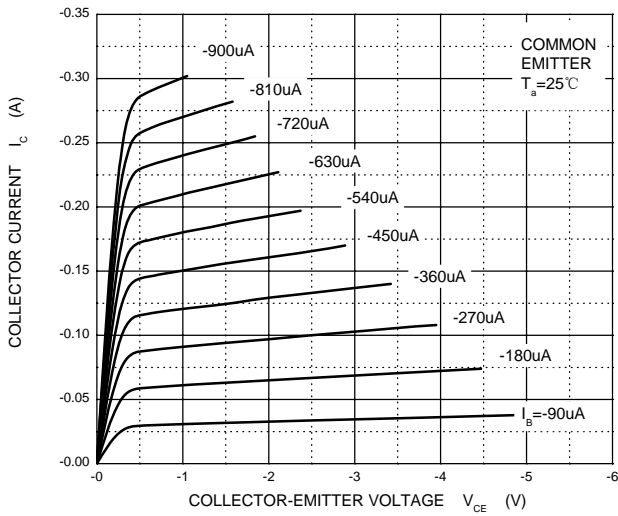

$h_{FE} - I_c$

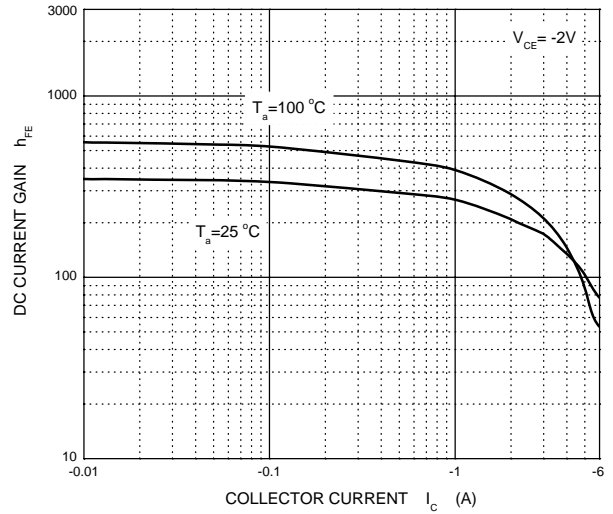

$I_c - V_{BE}$

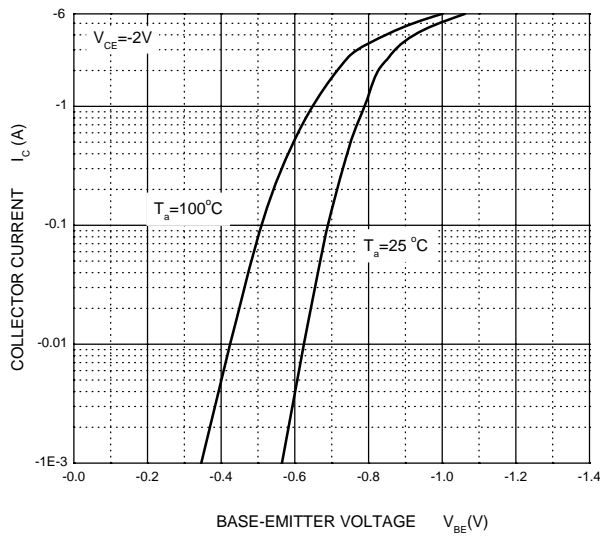

$V_{BEsat} - I_c$

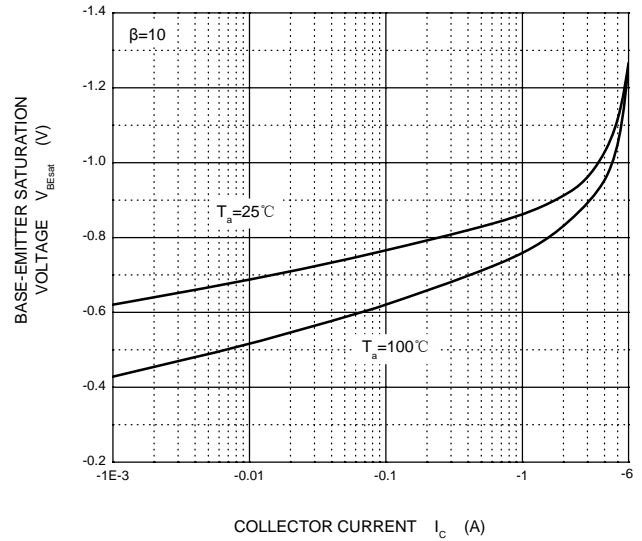

$V_{CEsat} - I_c$

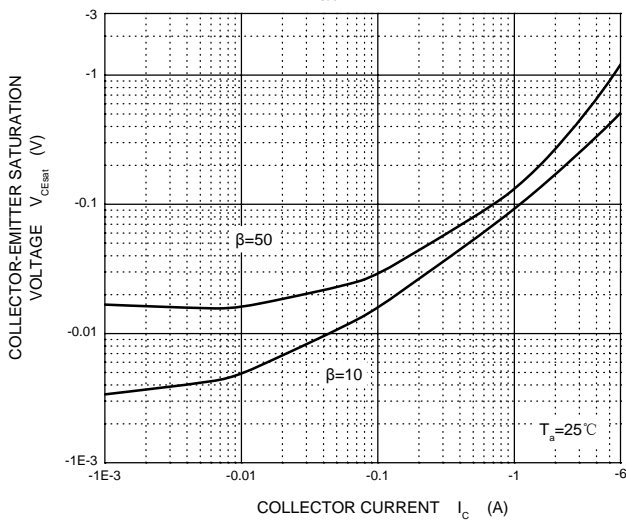

$V_{CEsat} - I_c$

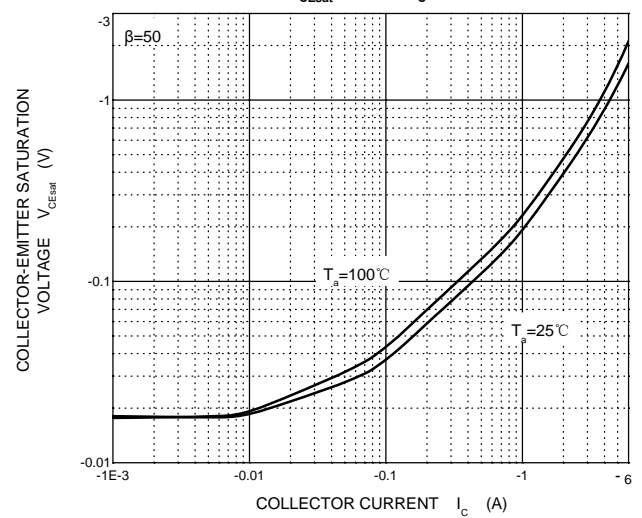

PNP TRANSISTOR TYPICAL CHARACTERISTICS

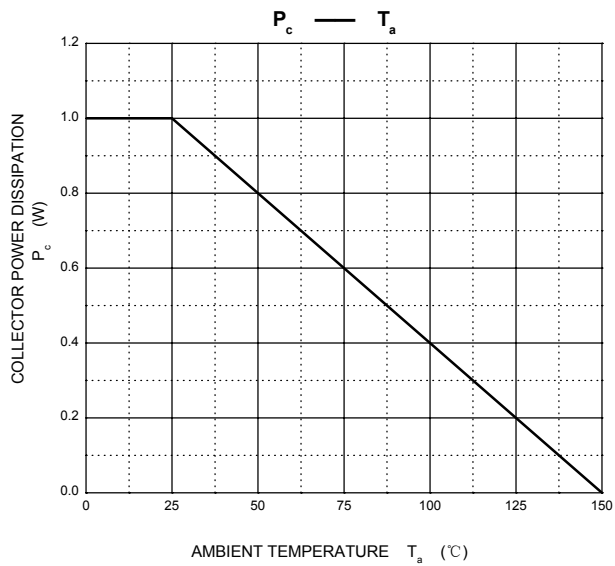
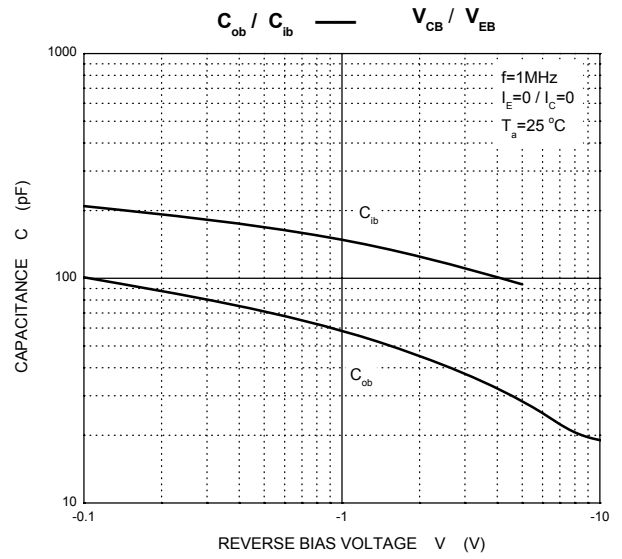
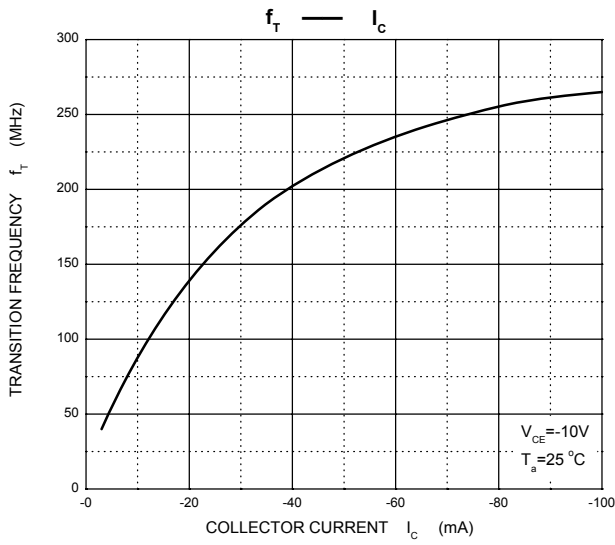

MOSFET TYPICAL CHARACTERISTICS(25°C, unless otherwise noted)

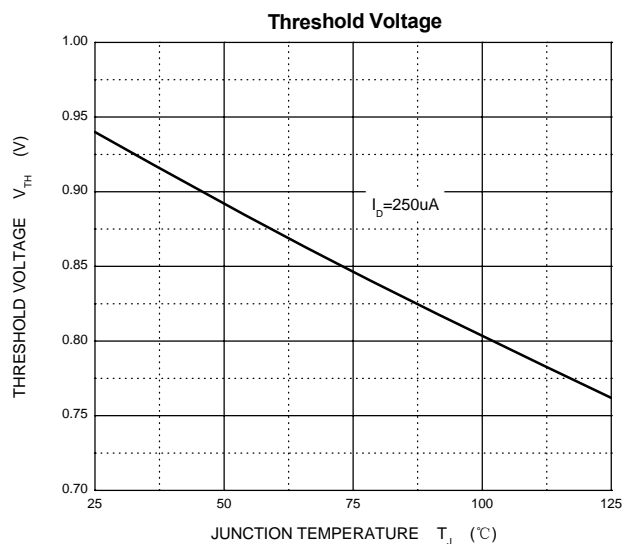
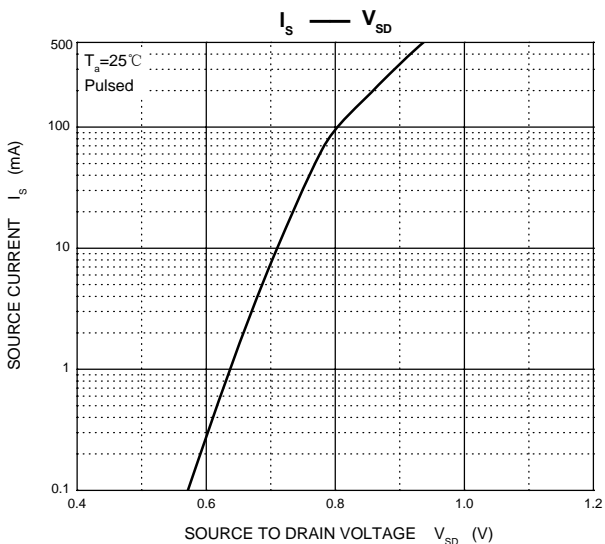
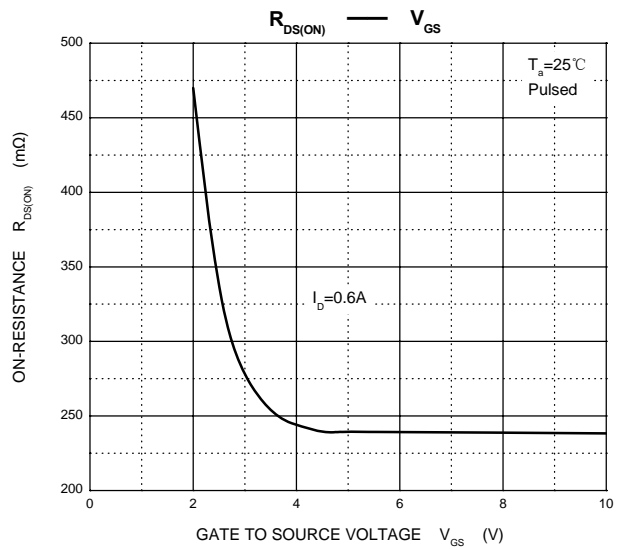
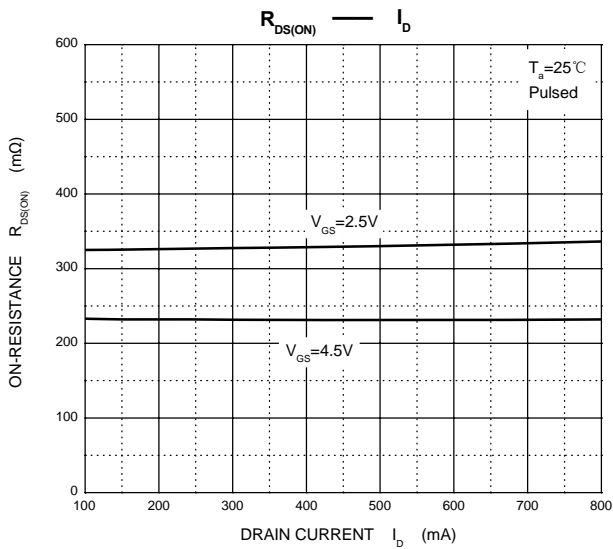
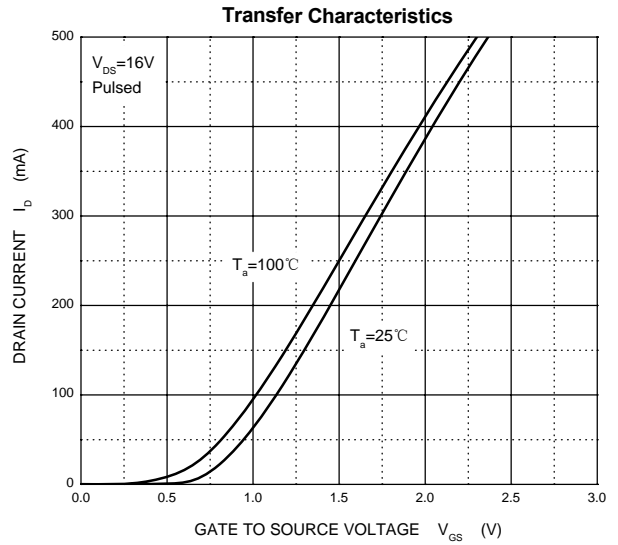
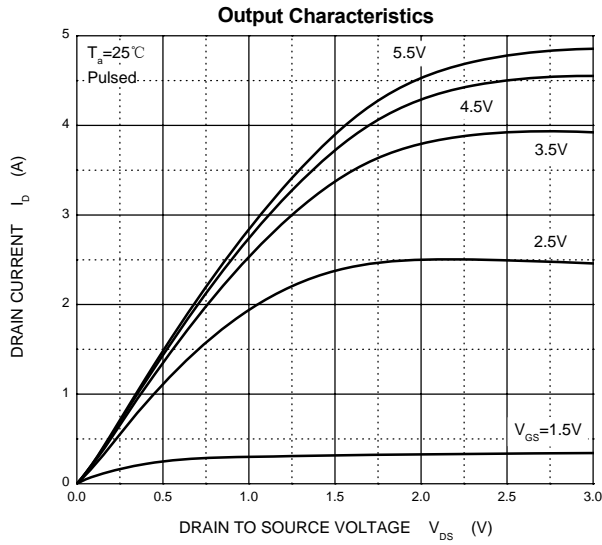

DFN3X2-8L Package Information

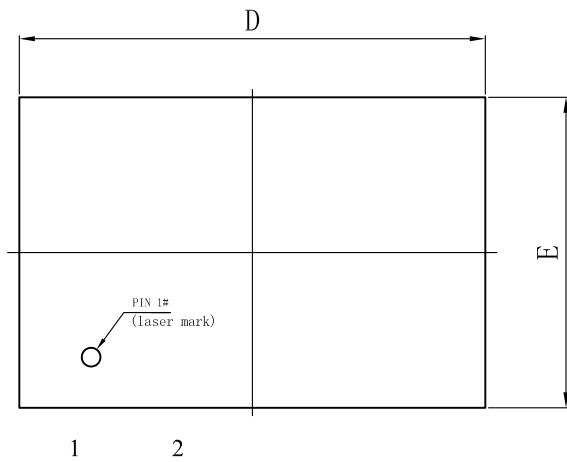

Top View

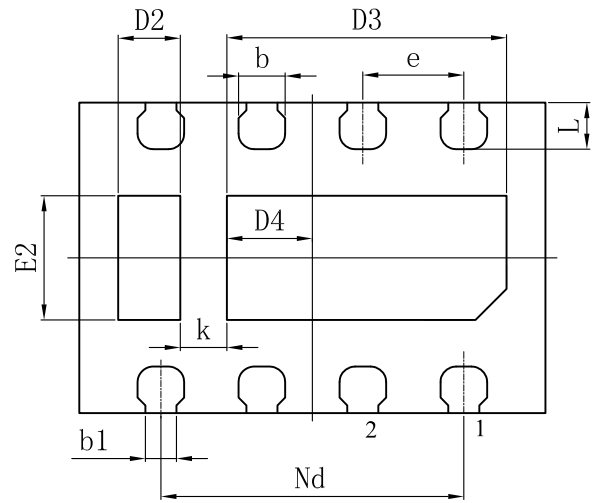

Bottom View

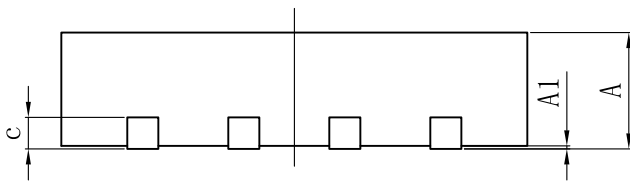

Side View

SYMBOL	MILLIMETER		
	MIN	NOM	MAX
A	0.70	0.75	0.80
A1	0	0.02	0.05
b	0.25	0.30	0.35
b1	0.15	0.20	0.25
c	0.15	0.20	0.25
D	2.90	3.00	3.10
D2	0.30	0.40	0.50
D3	1.70	1.80	1.90
D4	0.45	0.55	0.65
e	0.65BSC		
Nd	1.95BSC		
E	1.90	2.00	2.10
E2	0.70	0.80	0.90
L	0.25	0.30	0.35
K	0.25	0.30	0.35