

ECG P-Channel Enhancement Mode Power MOSFET

Description

The ECG1216 uses advanced trench technology to provide excellent $R_{DS(ON)}$, low gate charge and operation with gate voltages. This device is suitable for use as a load switching application and a wide variety of other applications.

General Features

- $V_{DS} = -12V, I_D = -16A$
 $R_{DS(ON)} < 22m\Omega @ V_{GS} = -2.5V$
 $R_{DS(ON)} < 18m\Omega @ V_{GS} = -4.5V$
- Advanced trench MOSFET process technology
- Ultra low on-resistance with low gate charge

Application

- PWM applications
- Load switch
- Battery charge in cellular handset

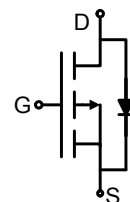

Schematic diagram

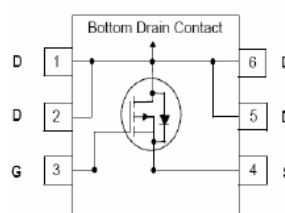

Pin assignment

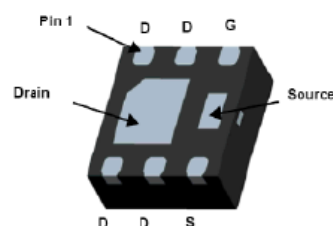

DFN2X2-6L bottom view

Package marking and ordering information

Device Marking	Device	Device Package	Reel Size	Tape Width	Quantity
ECG1216	ECG1216	DFN2X2-6L	-	-	-

Absolute maximum ratings ($T_C = 25^\circ C$ unless otherwise noted)

Parameter	Symbol	Limit	Unit
Drain-Source Voltage	V_{DS}	-12	V
Gate-Source Voltage	V_{GS}	± 12	V
Drain Current-Continuous	I_D	-16	A
Drain Current -Pulsed	I_{DM}	-65	A
Maximum Power Dissipation	P_D	18	W
Operating Junction and Storage Temperature Range	T_J, T_{STG}	-55 To 150	$^\circ C$

Thermal Characteristic

Thermal Resistance, Junction-to-Case	$R_{\theta JC}$	6.9	$^\circ C/W$
--------------------------------------	-----------------	-----	--------------

Electrical characteristics (T_A=25°C unless otherwise noted)

Parameter	Symbol	Condition	Min	Typ	Max	Unit
Off Characteristics						
Drain-Source Breakdown Voltage	V _{(BR)DSS}	V _{GS} =0V I _D =-250μA	-12	-	-	V
Zero Gate Voltage Drain Current	I _{DSS}	V _{DS} =-12V, V _{GS} =0V	-	-	-1	μA
Gate-Body Leakage Current	I _{GSS}	V _{GS} =±12V, V _{DS} =0V	-	-	±100	nA
On Characteristics						
Gate Threshold Voltage	V _{GS(th)}	V _{DS} =V _{GS} , I _D =-250μA	-0.4	-0.7	-1	V
Drain-Source On-State Resistance	R _{DS(ON)}	V _{GS} =-4.5V, I _D =-6.7A	-	11.5	18	mΩ
		V _{GS} =-2.5V, I _D =-6.2A	-	14	22	mΩ
Forward Transconductance	g _{FS}	V _{DS} =-5V, I _D =-6.7A	20	-	-	S
Dynamic Characteristics						
Input Capacitance	C _{iss}	V _{DS} =-10V, V _{GS} =0V, F=1.0MHz	-	2700	-	PF
Output Capacitance	C _{oss}		-	680	-	PF
Reverse Transfer Capacitance	C _{rss}		-	590	-	PF
Switching Characteristics						
Turn-on Delay Time	t _{d(on)}	V _{DD} =-10V, I _D =-1A V _{GS} =-4.5V, R _{GEN} =10Ω	-	11	-	nS
Turn-on Rise Time	t _r		-	35	-	nS
Turn-Off Delay Time	t _{d(off)}		-	30	-	nS
Turn-Off Fall Time	t _f		-	10	-	nS
Total Gate Charge	Q _g	V _{DS} =-6V, I _D =-10A, V _{GS} =-4.5V	-	35	48	nC
Gate-Source Charge	Q _{gs}		-	5	-	nC
Gate-Drain Charge	Q _{gd}		-	10	-	nC
Drain-Source Diode Characteristics						
Diode Forward Voltage	V _{SD}	V _{GS} =0V, I _S =-8A	-	-	-1.2	V
Diode Forward Current	I _S		-	-	-16	A

Typical Electrical and Thermal Characteristics

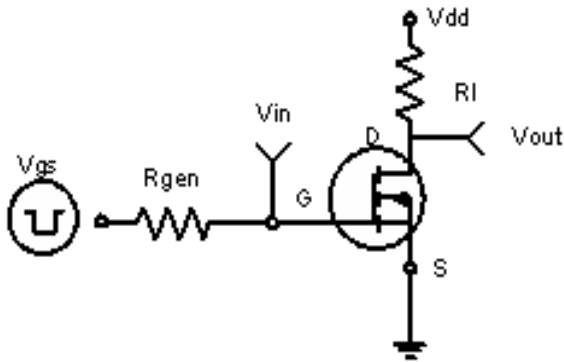

Figure 1: Switching Test Circuit

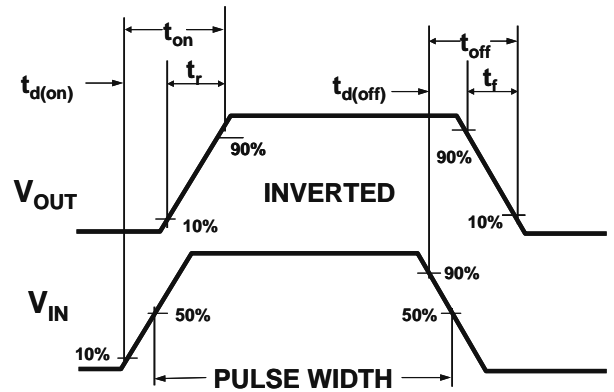

Figure 2: Switching Waveforms

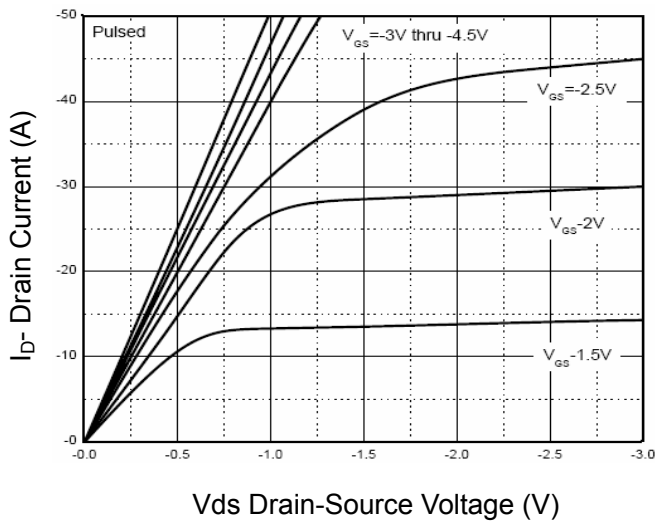

Figure 3 Output Characteristics

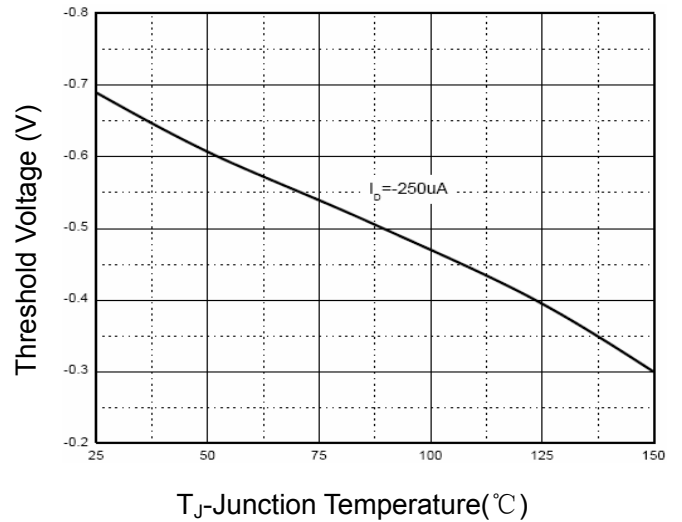

Figure 4 Drain Current

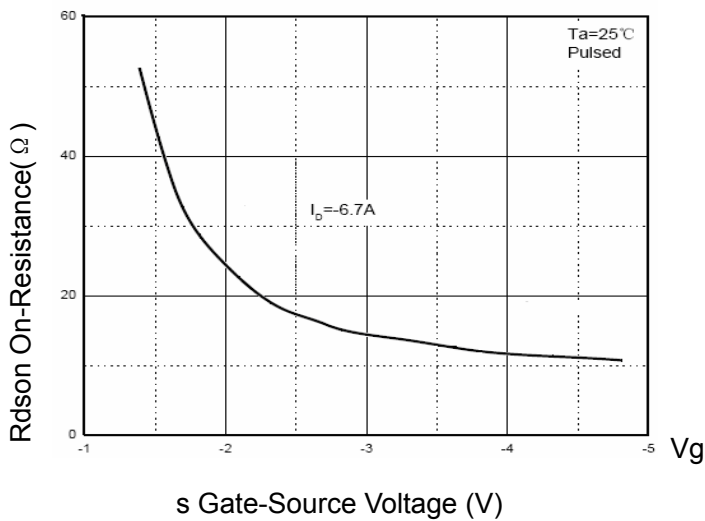

Figure 5 Rdson vs Vgs

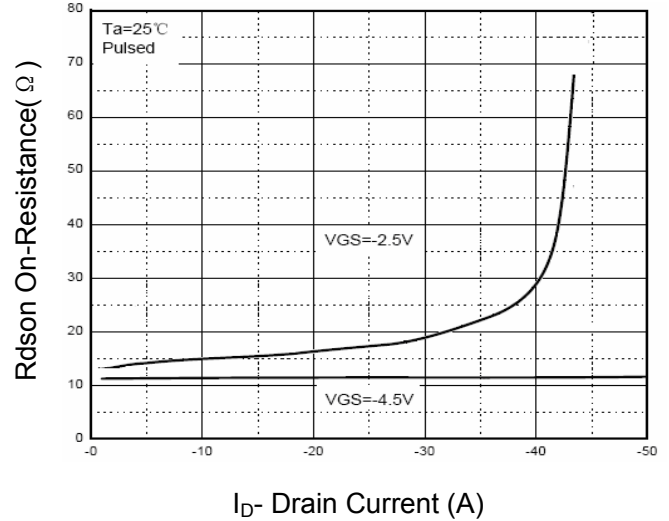
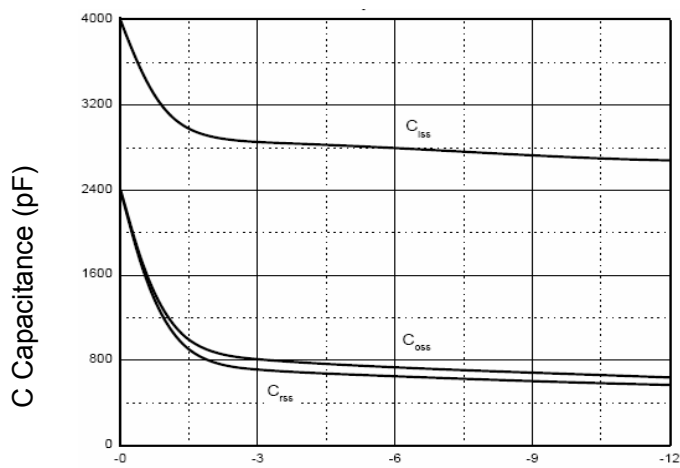
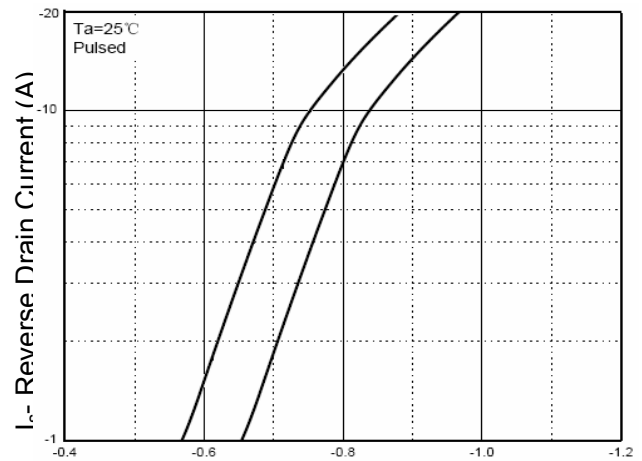

Figure 6 Drain-Source On-Resistance



V_{ds} Drain-Source Voltage (V)
Figure 7 Capacitance vs V_{ds}



V_{sd} Source-Drain Voltage (V)
Figure 8 Source- Drain Diode Forward

DFN2X2-6L Package Information

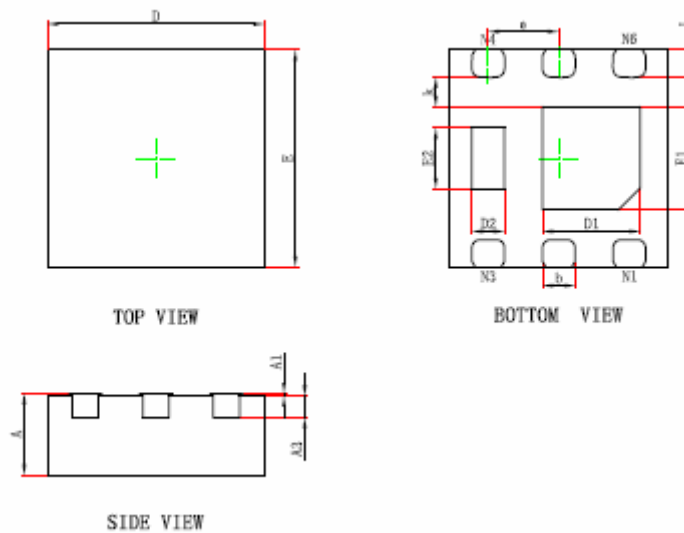

Symbol	Dimensions In Millimeters		Dimensions In Inches	
	Min.	Max.	Min.	Max.
A	0.700	0.800	0.028	0.031
A1	0.000	0.050	0.000	0.002
A3	0.203REF.		0.008REF.	
D	1.924	2.076	0.076	0.082
E	1.924	2.076	0.076	0.082
D1	0.800	1.000	0.031	0.039
E1	0.850	1.050	0.033	0.041
D2	0.200	0.400	0.008	0.016
E2	0.460	0.660	0.018	0.026
k	0.200MIN.		0.008MIN.	
b	0.250	0.350	0.010	0.014
e	0.650TYP.		0.026TYP.	
L	0.174	0.326	0.007	0.013

Notes

1. All dimensions are in millimeters.
2. Tolerance $\pm 0.10\text{mm}$ (4 mil) unless otherwise specified
3. Package body sizes exclude mold flash and gate burrs. Mold flash at the non-lead sides should be less than 5 mils.
4. Dimension L is measured in gauge plane.
5. Controlling dimension is millimeter, converted inch dimensions are not necessarily exact.