

ECP24VN20AT3L1

High Power TVS Diode

The ECP24VN20AT3L1 is a high power TVS, utilizing leading monolithic silicon technology to provide fast response time and low ESD clamping voltage, making this device an ideal solution for protecting voltage sensitive lines. The ECP24VN20AT3L1 Series complies with the IEC 610002 (ESD) standard with $\pm 30\text{kV}$ air and $\pm 30\text{kV}$ contact discharge. It is assembled into a 3pin DFN2020 package. The leads are finished with NiPdAu. Each device will protect one line. The combination of small size, and high surge capability makes them ideal for use in applications such as cellular phones, LCD displays, USB, and multimedia card interfaces.

Features

- Protects one I/O lines
- Working voltages : 24V
- 6000W peak pulse power (8/20 μs)
- Low leakage current
- Response Time is < 1 ns
- Meets MSL 1 Requirements
- Solid-state silicon avalanche technology
- ROHS compliant



DFN2020-3L

Main applications

- Power Management
- Industrial Application
- Power Supply Protection

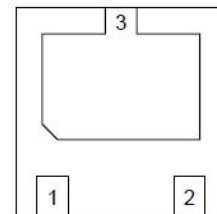

Protection solution to meet

- IEC61000-4-2 (ESD) $\pm 30\text{kV}$ (air), $\pm 30\text{kV}$ (contact)
- IEC61000-4-4 (EFT) 40A (5/50ns)
- IEC61000-4-5 (Lightning) 200A (8/20 μs)

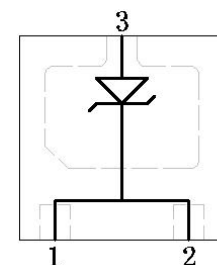

Ordering Information

Device	Mark	Qty per Reel	Reel Size
ECP24VN20AT3L1	24AF	3000	7 Inch

Maximum ratings (Temp=25°C Unless Otherwise Specified)

Parameter	Symbol	Value	Unit
Peak Pulse Power (tp=8/20μs waveform)	P _{PPP}	6000	Watts
ESD Rating per IEC61000-4-2:	Contact	30	KV
	Air	30	
Lead Soldering Temperature	T _L	260 (10 sec.)	°C
Operating Temperature Range	T _J	-55 ~ 150	°C
Storage Temperature Range	T _{STG}	-55 ~ 150	°C

Maximum ratings are those values beyond which device damage can occur. Maximum ratings applied to the device are individual stress limit values (not normal operating conditions) and are not valid simultaneously. If these limits are exceeded, device functional operation is not implied, damage may occur and reliability may be affected.

*Other voltages may be available upon request.

1. Non-repetitive current pulse, per Figure 1.

Electrical characteristics (Temp=25°C Unless Otherwise Specified)

Symbol	Parameter	Conditions	Min.	Typ.	Max.	Units
V _{RWM}	Reverse Working Voltage	Pin 3 to pin 1,2			24	V
V _{BR}	Reverse Breakdown Voltage	I _T = 1mA, Pin 3 to pin 1,2	27.3			V
I _R	Reverse Leakage Current	V _{RWM} =24V, Pin 3 to pin 1,2			1	μA
V _C	Clamping Voltage	I _{PP} = 50A, tp =8/20μs, Pin 3 to pin 1,2		25.8		V
		I _{PP} =200A, tp =8/20μs, Pin 3 to pin 1,2		30	34	V
C _J	Junction Capacitance	V _R = 0V, f = 1MHz, Pin 3 to pin 1,2		740		pF

Junction capacitance is measured in VR=0V,F=1MHz

Symbol	Parameter
V _{RWM}	Working Peak Reverse Voltage
V _{BR}	Breakdown Voltage @ I _T
V _C	Clamping Voltage @ I _{PP}
I _T	Test Current
I _{RM}	Leakage current at V _{RWM}
I _{PP}	Peak pulse current
C _O	Off-state Capacitance
C _J	Junction Capacitance

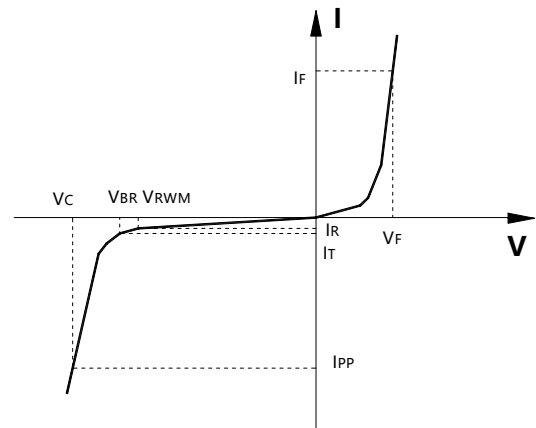

Typical electrical characterist applications

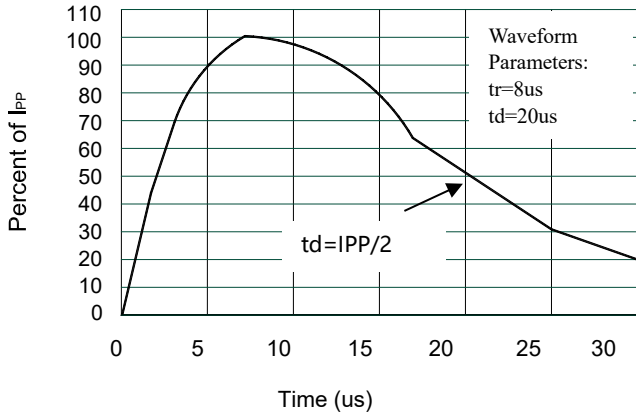

Pulse Waveform

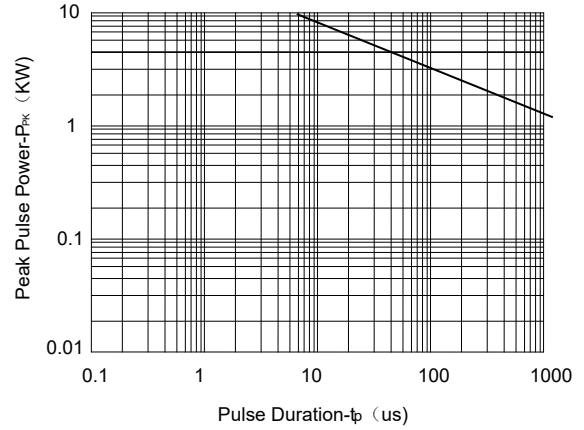

Non-Repetitive Peak Pulse Power vs. Pulse Time

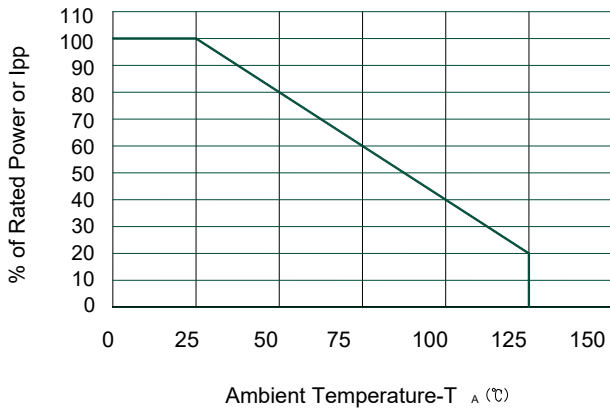

Power Derating Curve

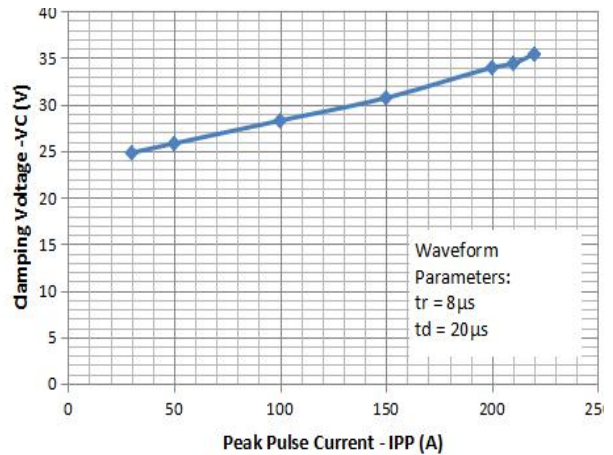

Clamping Voltage vs. Peak Pulse Current

Package Information

DFN2020-3L

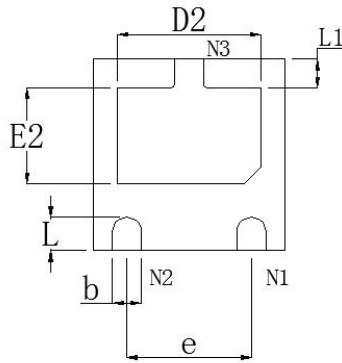
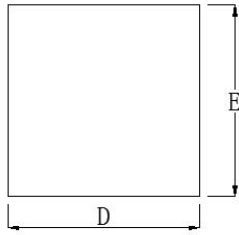

DIM	Millimeters		
	Min	Nom	Max
A	0.50	0.55	0.60
A1	0.00	-	0.05
A3	0.15 REF.		
D	1.95	2.00	2.05
E	1.95	2.00	2.05
b	0.25	0.30	0.35
L	0.30	0.35	0.40
L1	0.25	0.30	0.35
D2	1.35	1.50	1.60
E2	0.85	1.00	1.10
e	1.30 BSC		

Recommended Pad outline

